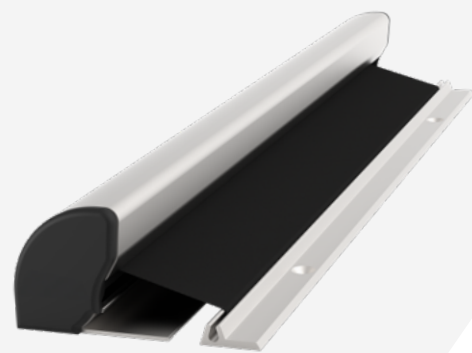

## FINGER PROTECTION DEVICES

**FP400 / FP400 XL****DESCRIPTION**

Suitable for most **single and double action doors** including automatic doors, utilising a roller system to provide effective finger protection; preventing fingers being accidentally trapped on the hinge side of a door.

Featuring a sleek, easy to clean, aluminium housing. Strong **fire-retardant fabric** material is kept under constant tension, designed to cover the gap between the door and frame automatically when the door is opened.

The housing is designed to conceal screws when the door is closed.



Closed



Open

**TECHNICAL DATA**

Information	FP400	FP400 XL
Cycles of operations	1,000,000	-
Maximum length	2500mm	2500mm
Standard length	1925mm	2015mm
Minimum length	325mm	325mm
Maximum fabric travel	260mm	320mm

- Additional Info
- Suitable for use on 30min fire doors
  - Class 2 - BS 8613:2017 Finger Protection for Pedestrian Doors
  - EN16654:2015 Child Protection Products
  - Designed for situations where a wider gap needs to be covered

**HOUSING FINISH OPTIONS**

-  White (RAL 9016)
-  Satin Anodised Aluminium (SAA)
-  Dark Bronze Anodised (DBA)

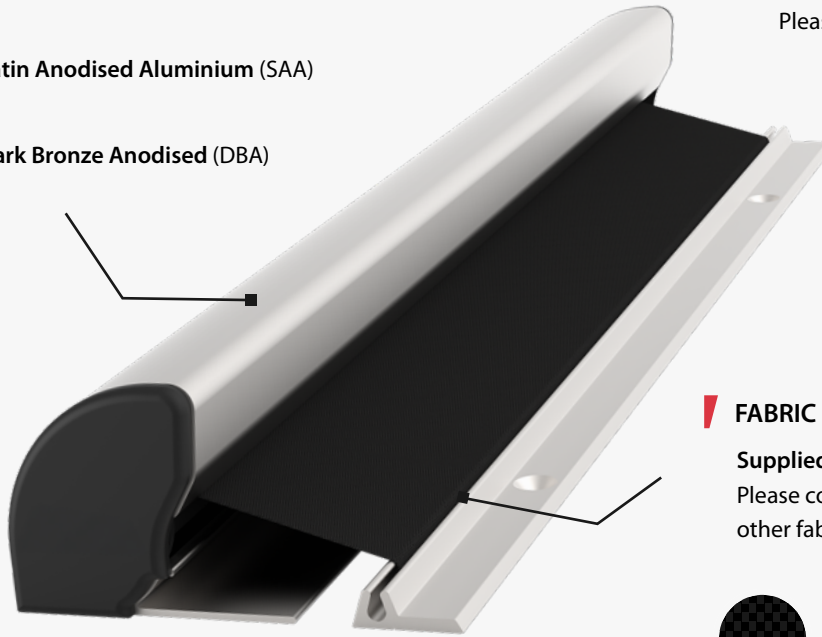







**BESPOKE FINISHES**

Housing RAL colour match available on request (POA).  
Please contact us to enquire.

**FABRIC COLOUR**

Supplied in black as standard fabric.  
Please contact us to enquire about our other fabric colour options.

-  Black (Standard)
-  White
-  Yellow
-  Bordeaux
-  Blue
-  Green

**DIMENSIONS**

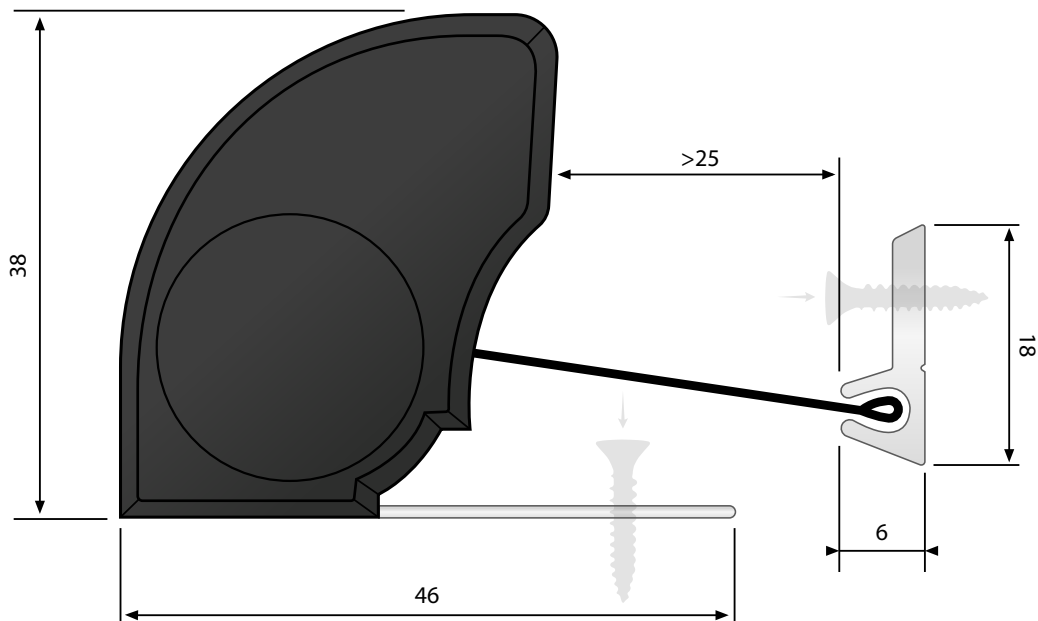

Awarded German Safety Mark and certified to EN16654

