

Guttermaster SnapLok wall capping available in 1.5mm, 2.0mm, 2.5mm or 3.0mm aluminium to suit required size. Finished as natural aluminium, anodised, or polyester powder coated in a full range of RAL & BS colours.

SnapLok bracket lined, levelled and secured to substructure. Bracket finish to match SnapLok capping

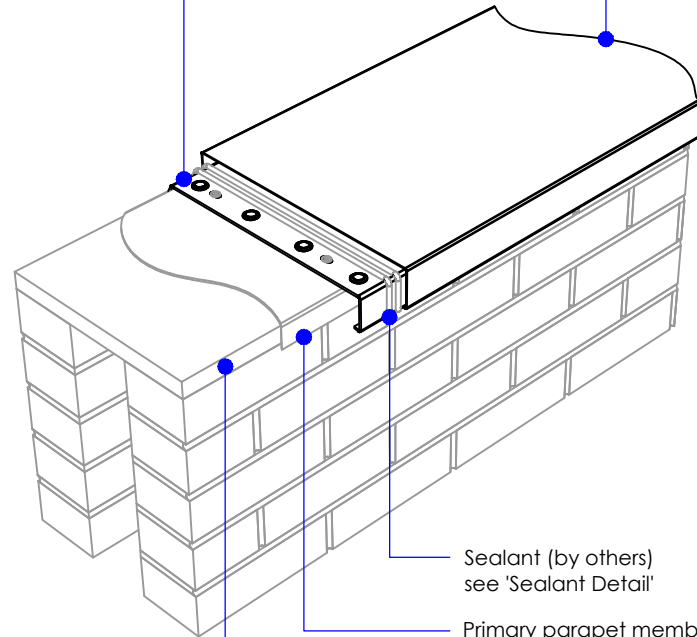

Sealant (by others) see 'Sealant Detail'
Primary parapet membrane (by others)
Secure substructure (by others)

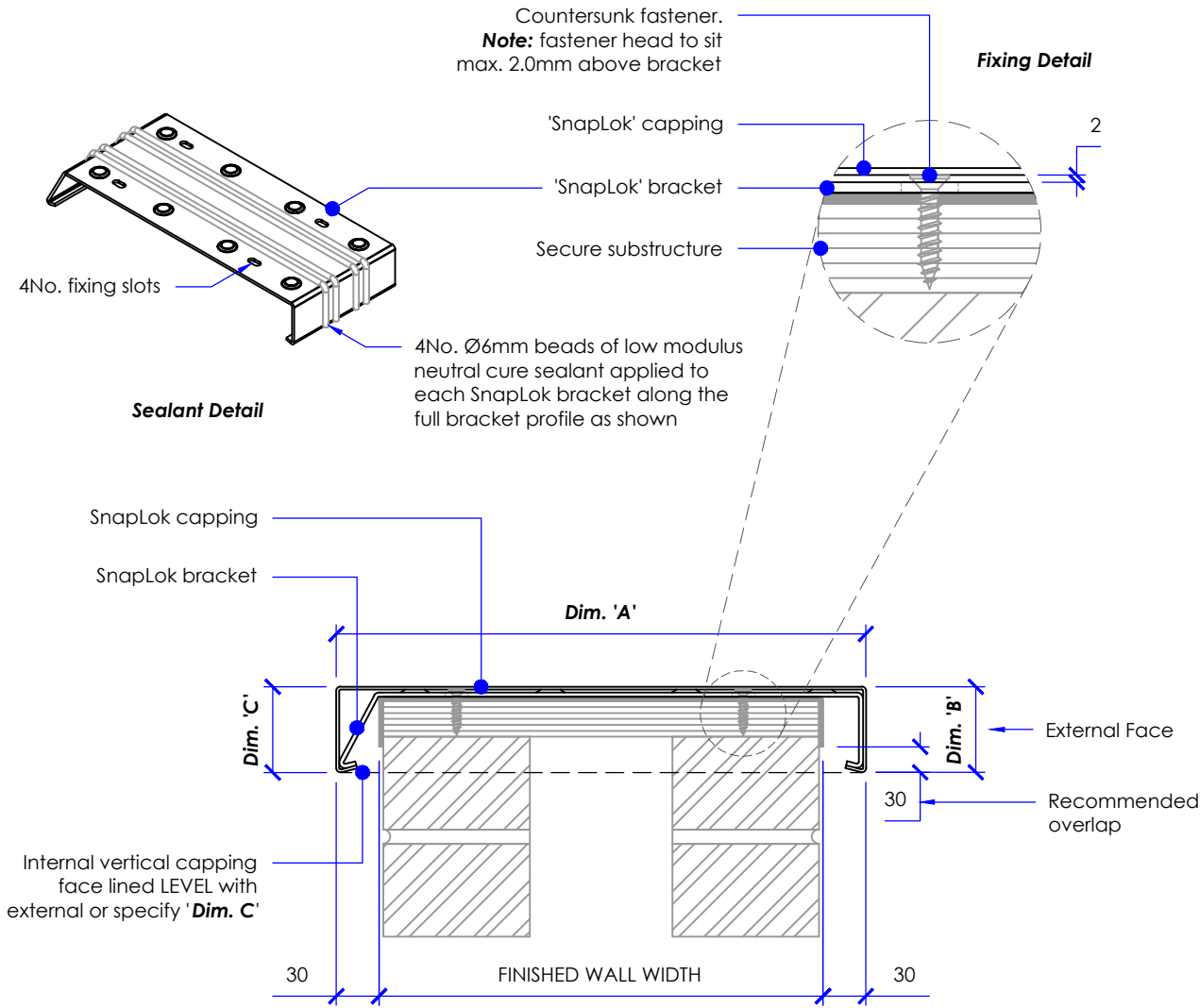

General Notes:

All dimension must be checked on site and any discrepancies reported to Guttermaster Ltd. prior to commencement of site work.
Do not scale from this drawing - use figured dimensions only.
This drawing remains the property of Guttermaster Ltd. and must not be copied or disclosed to a third party without prior consent.
If in doubt ask!

Assembly Recommendations:

P.V.C. isolating tape to be placed between dissimilar metal surfaces.
Use austenitic stainless steel fasteners with low profile heads where dissimilar metals are present - Supplier SFS Intec, Irius fixings.
Pre-drill holes for fixings. 1mm clearance around fixing to allow for expansion and thus prevent profile distortion.
Allow 1mm per metre expansion gap between profile lengths (e.g. 3mm gap between 3000mm profile lengths).
Apply low-modulus silicone sealant between union and profile.
For project specific requirements please contact Guttermaster Ltd.

001 'SNAPLOK' DETAIL AT JOINT LOCATION
1 ISOMETRIC VIEW N.T.S.

001 'SNAPLOK' DETAIL AT INTERMEDIATE BRACKET LOCATION
3 SECTION DETAIL SCALE 1 : 5

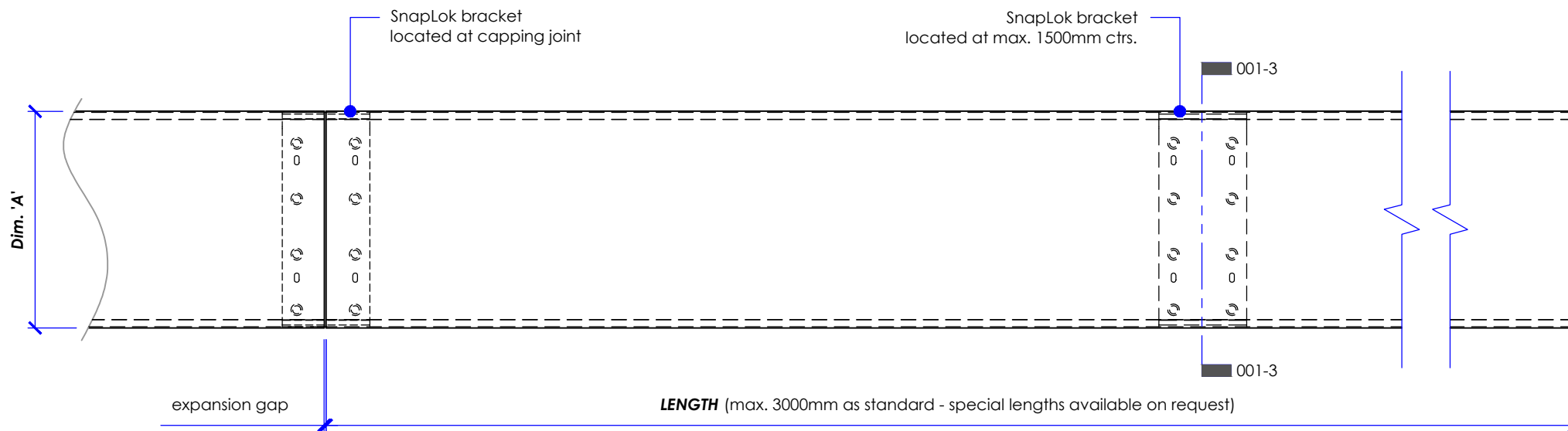

001 'SNAPLOK' COMPONENT DETAIL
2 VIEW ON PLAN SCALE 1 : 10

GUTTERmaster

ALUMINIUM IN CONSTRUCTION

Shawclough Trading Estate,
Shawclough Road,
Rochdale,
Lancashire,
OL12 6ND

Tel: 01706 869550
Fax: 01706 869551
e-mail: technical@guttermaster
web: www.guttermaster.co.uk

Client:	-	Date:	-
Project:	-	Approved by:	-
Title: TYPICAL LAID LEVEL SNAPLOK CAPPING DETAIL			
Drawing Status: ISSUE FOR INFORMATION			
Drawn by:	Checked by:	Date:	Approved by:
A.S.	-	01-03-2012	-
Sheet size:	Scale:	Sheet No. (of sheets):	Drawing No:
A3	as shown	1 (of 1)	SL-01-001
			Revision:
			-

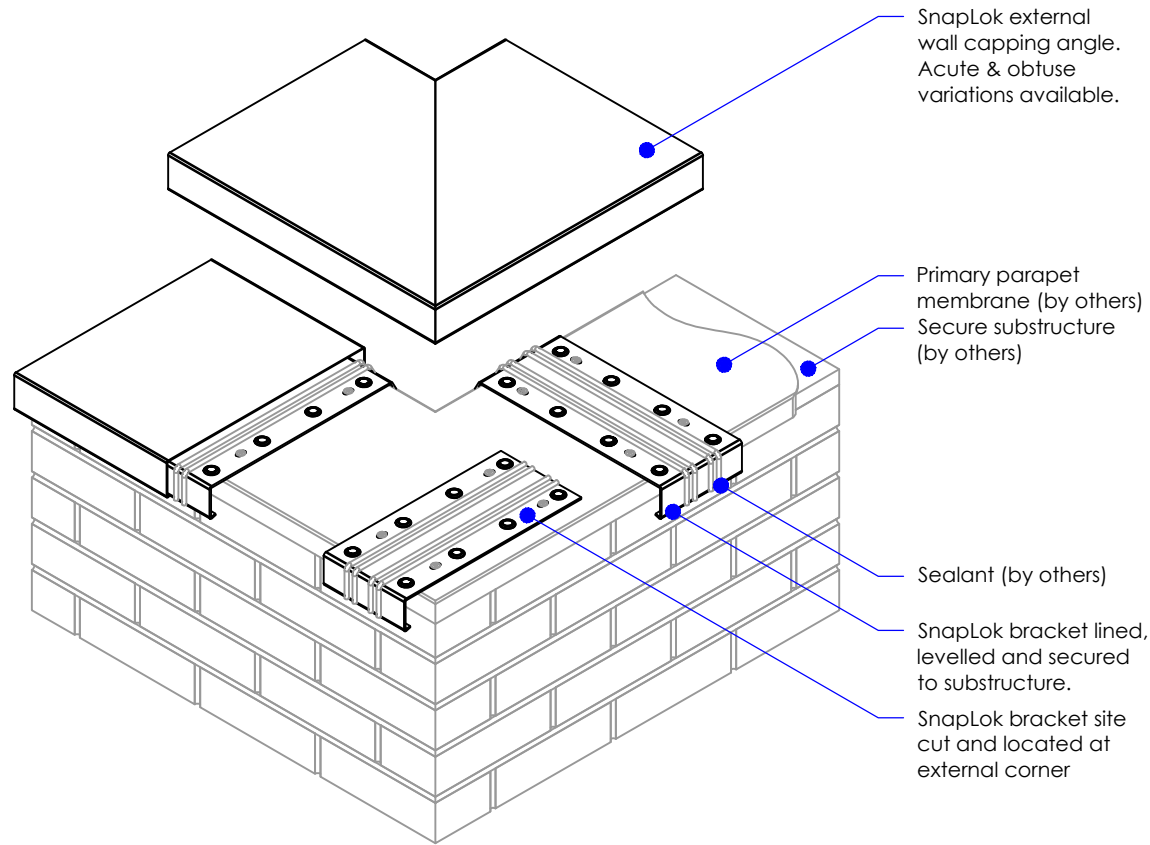

002 'SNAPLOK' EXTERNAL ANGLE DETAIL
1 ISOMETRIC VIEW N.T.S.

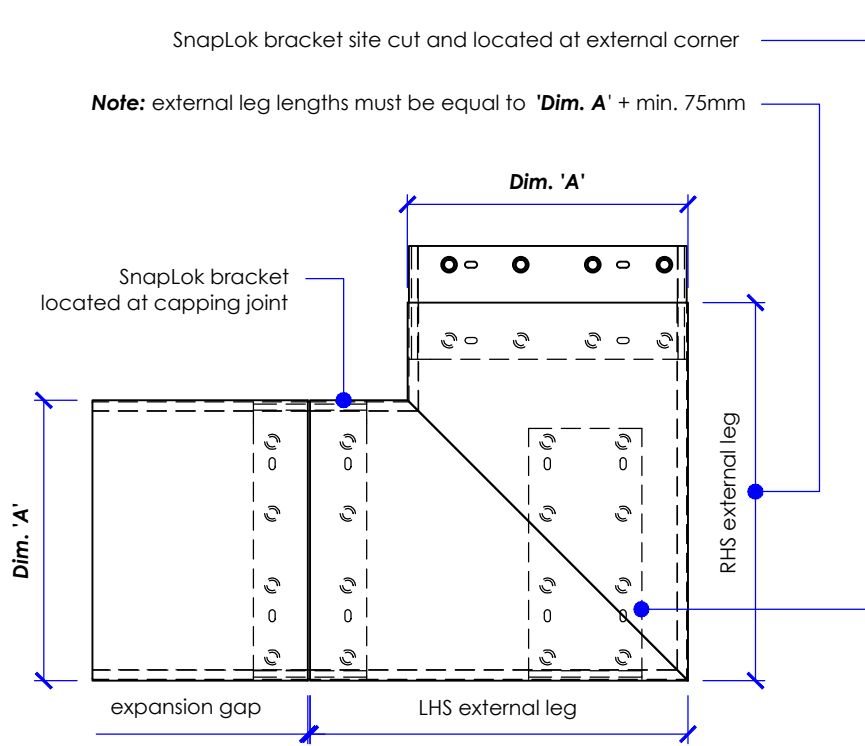

002 'SNAPLOK' EXTERNAL ANGLE COMPONENT DETAIL
2 VIEW ON PLAN SCALE 1 : 10

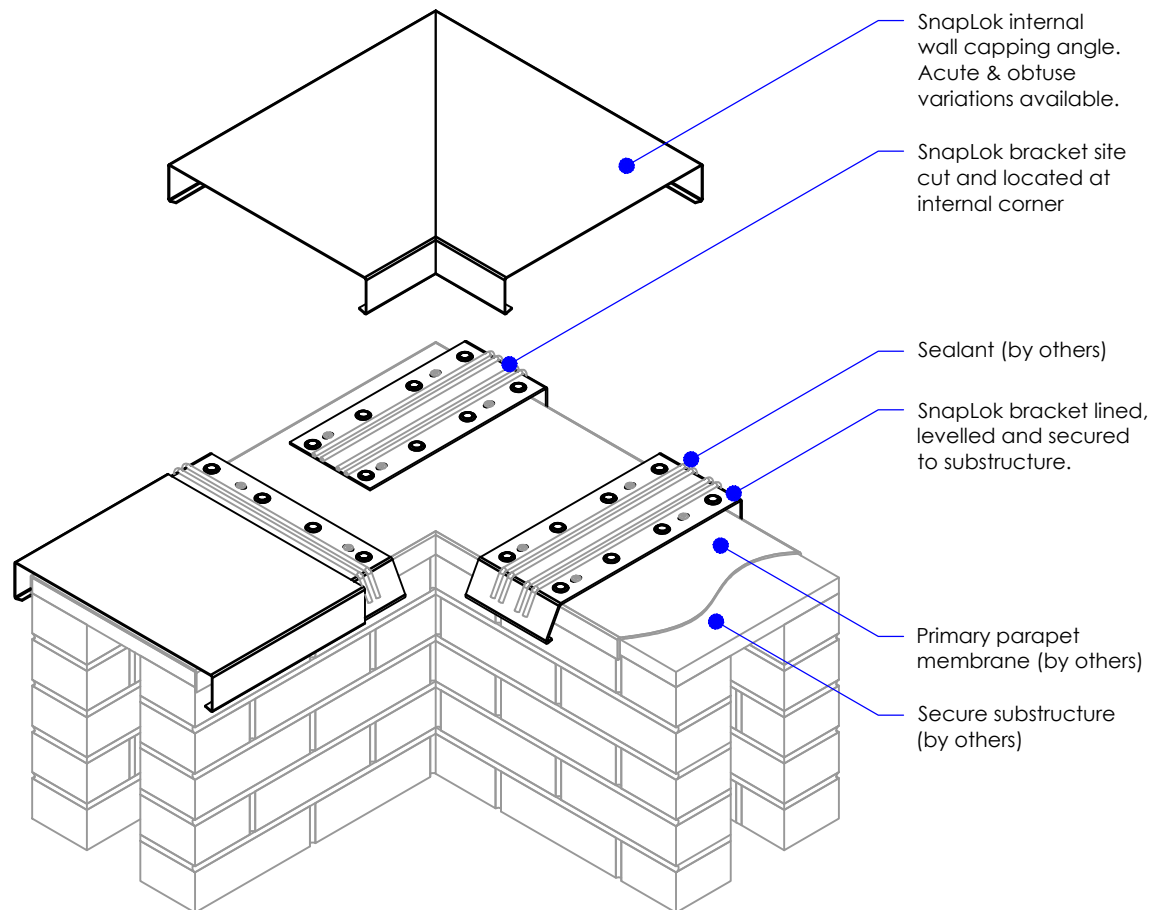

002 'SNAPLOK' INTERNAL ANGLE DETAIL
3 ISOMETRIC VIEW N.T.S.

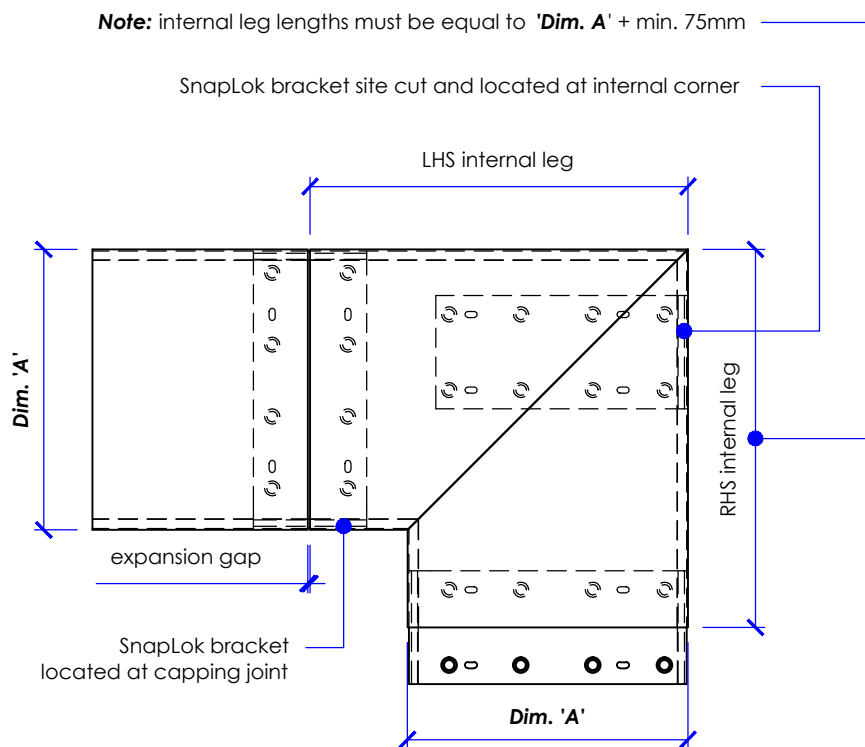

002 'SNAPLOK' INTERNAL ANGLE COMPONENT DETAIL
4 VIEW ON PLAN SCALE 1 : 10

General Notes:

All dimension must be checked on site and any discrepancies reported to Guttermaster Ltd. prior to commencement of site work.
Do not scale from this drawing - use figured dimensions only.
This drawing remains the property of Guttermaster Ltd. and must not be copied or disclosed to a third party without prior consent.
If in doubt ask!

Assembly Recommendations:

P.V.C. isolating tape to be placed between dissimilar metal surfaces.
Use austenitic stainless steel fasteners with low profile heads where dissimilar metals are present - Supplier SFS Intec, Irius fixings.
Pre-drill holes for fixings. 1mm clearance around fixing to allow for expansion and thus prevent profile distortion.
Allow 1mm per metre expansion gap between profile lengths (e.g. 3mm gap between 3000mm profile lengths).
Apply low-modulus silicone sealant between union and profile.
For project specific requirements please contact Guttermaster Ltd.

GUTTERmaster			
ALUMINIUM IN CONSTRUCTION			
Shawclough Trading Estate, Shawclough Road, Rochdale, Lancashire, OL12 6ND		Tel: 01706 869550 Fax: 01706 869551	
		e-mail: technical@guttermaster web: www.guttermaster.co.uk	
Client: -			
Project: -			
Title: TYPICAL LAID LEVEL SNAPLOK CAPPING CORNER DETAILS			
Drawing Status: ISSUE FOR INFORMATION			
Drawn by: A.S.	Checked by: -	Date: 01-03-2012	Approved by: -
Sheet size: A3	Scale: as shown	Sheet No. (of sheets): 1 (of 1)	Revision: -
		Drawing No: SL-01-002	

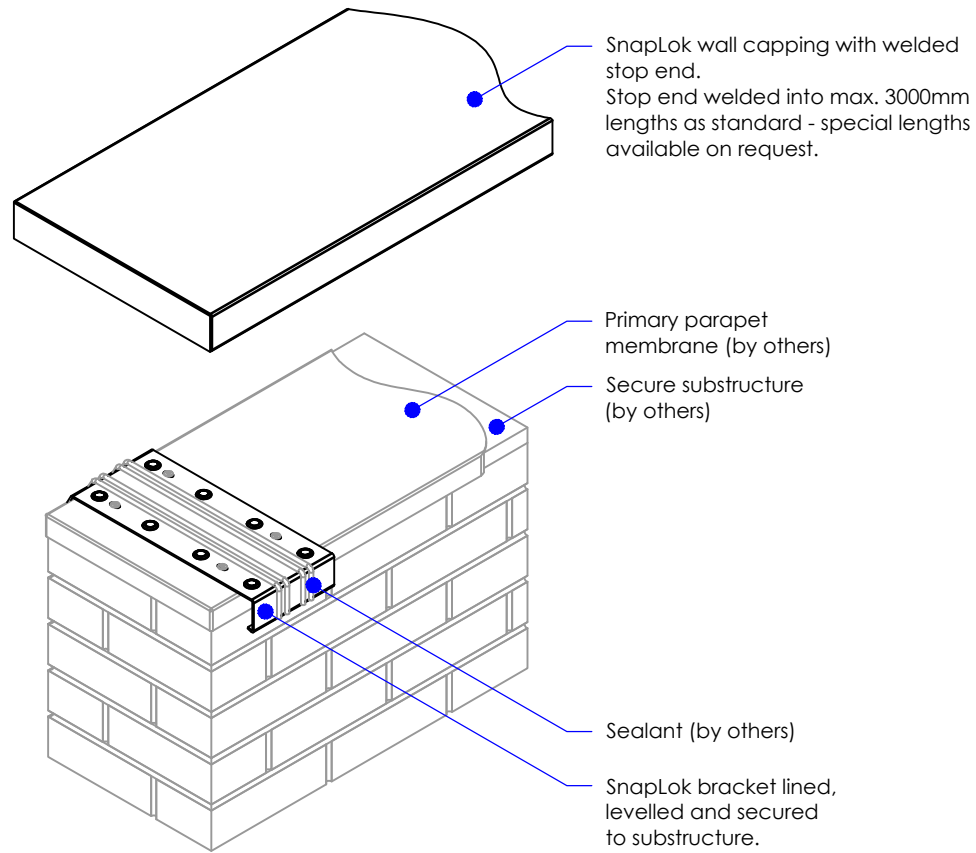

003 'SNAPLOK' WELDED STOP END DETAIL
1 ISOMETRIC VIEW N.T.S.

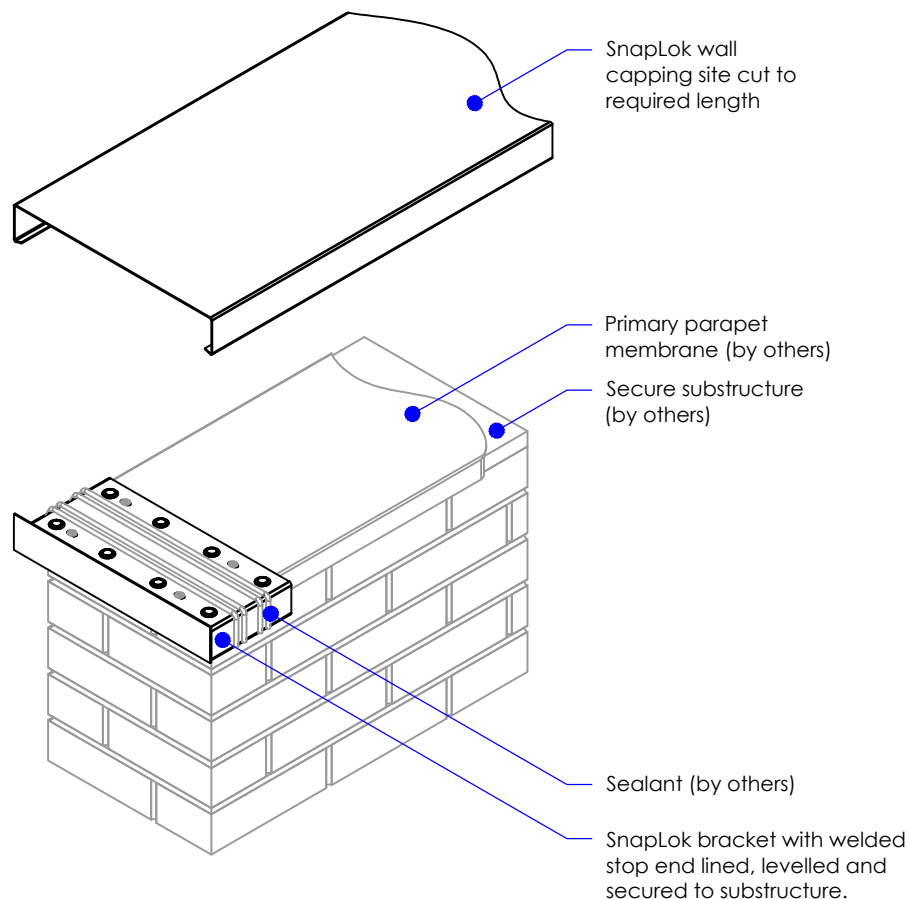

003 'SNAPLOK' INTERNAL STOP END DETAIL
2 ISOMETRIC VIEW N.T.S.

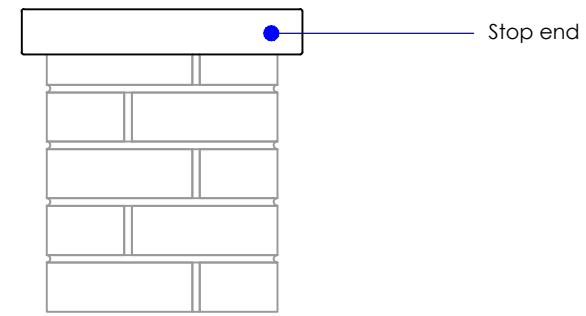

003 'SNAPLOK' STOP END DETAIL
3 VIEW ON STOP END SCALE 1 : 10

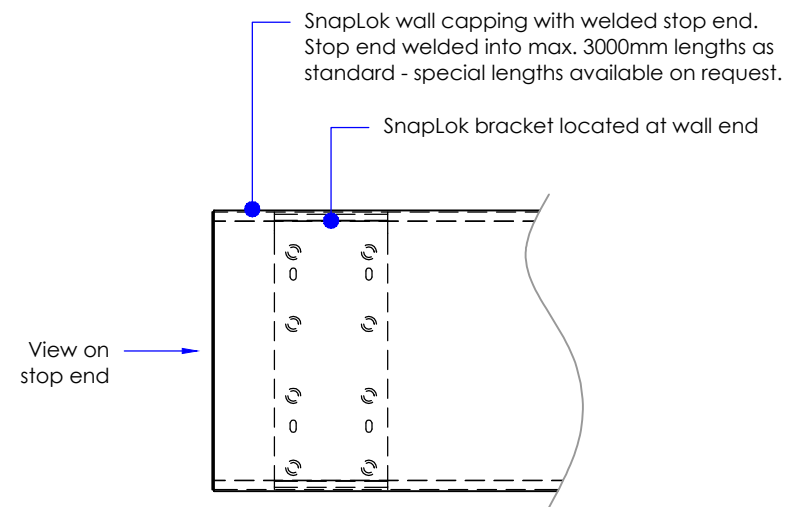

003 'SNAPLOK' WELDED STOP END COMPONENT DETAIL
4 VIEW ON PLAN SCALE 1 : 10

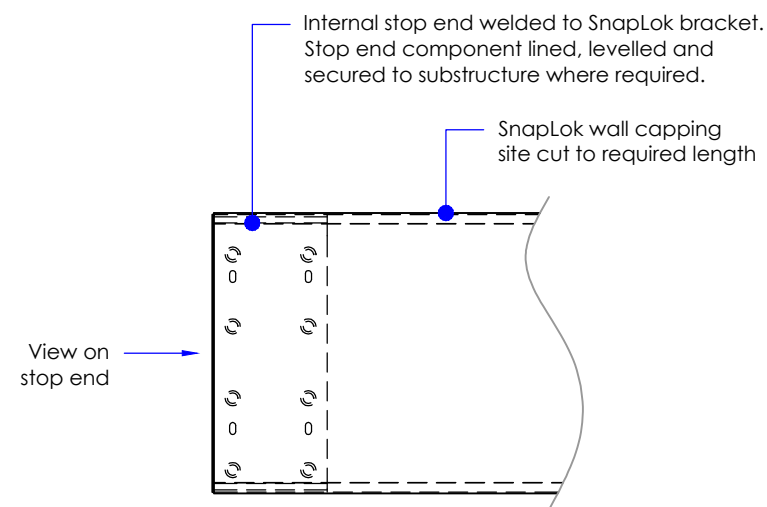

003 'SNAPLOK' INTERNAL STOP END COMPONENT DETAIL
5 VIEW ON PLAN SCALE 1 : 10

General Notes:

All dimension must be checked on site and any discrepancies reported to Guttermaster Ltd. prior to commencement of site work.

Do not scale from this drawing - use figured dimensions only.

This drawing remains the property of Guttermaster Ltd. and must not be copied or disclosed to a third party without prior consent.

If in doubt ask!

Assembly Recommendations:

P.V.C. isolating tape to be placed between dissimilar metal surfaces.

Use austenitic stainless steel fasteners with low profile heads where dissimilar metals are present - Supplier SFS Intec, Irius fixings.

Pre-drill holes for fixings. 1mm clearance around fixing to allow for expansion and thus prevent profile distortion.

Allow 1mm per metre expansion gap between profile lengths (e.g. 3mm gap between 3000mm profile lengths).

Apply low-modulus silicone sealant between union and profile.

For project specific requirements please contact Guttermaster Ltd.

GUTTERmaster			
ALUMINIUM IN CONSTRUCTION			
Shawclough Trading Estate, Shawclough Road, Rochdale, Lancashire, OL12 6ND		Tel: 01706 869550 Fax: 01706 869551 e-mail: technical@guttermaster web: www.guttermaster.co.uk	
Client:	-		
Project:	-		
Title:	TYPICAL LAID LEVEL SNAPLOK CAPPING STOP END DETAILS		
Drawing Status:	ISSUE FOR INFORMATION		
Drawn by:	Checked by:	Date:	Approved by:
A.S.	-	01-03-2012	-
Sheet size:	Scale:	Sheet No. (of sheets):	Drawing No:
A3	as shown	1 (of 1)	SL-01-003

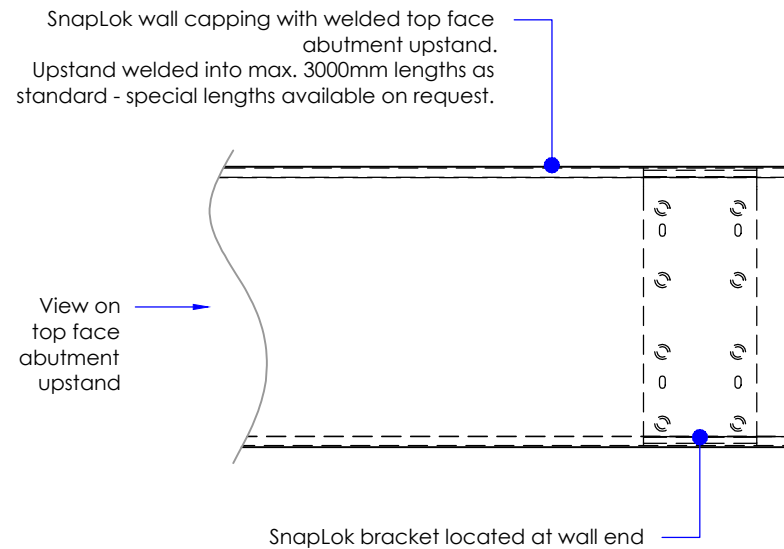
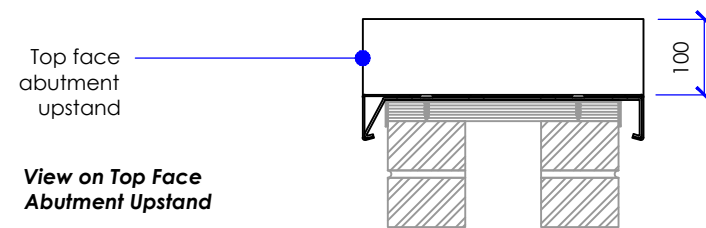
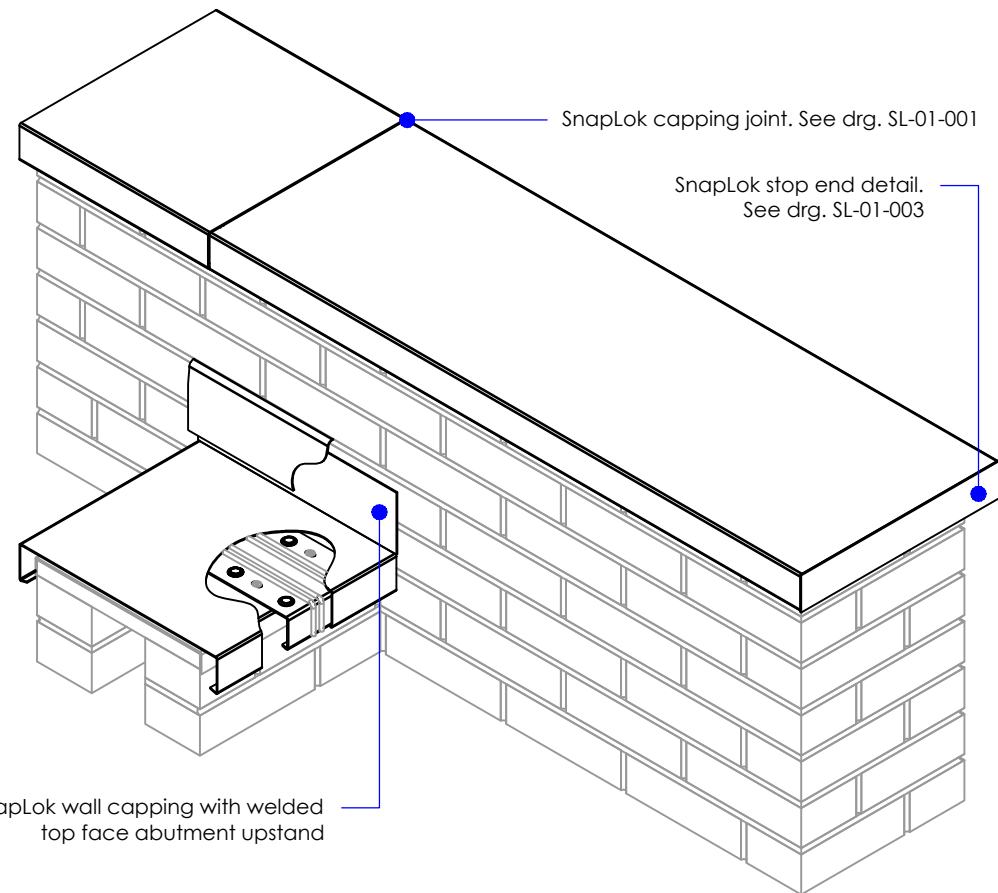

004 'SNAPLOK' WELDED TOP FACE ABUTMENT UPSTAND DETAIL
1 ISOMETRIC VIEW N.T.S.

004 'SNAPLOK' WELDED TOP FACE ABUTMENT UPSTAND COMPONENT DETAIL
2 VIEW ON PLAN SCALE 1 : 10

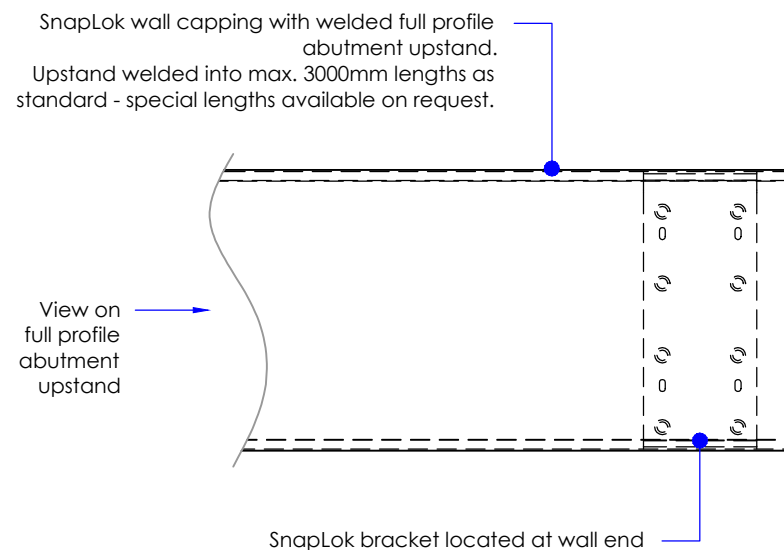
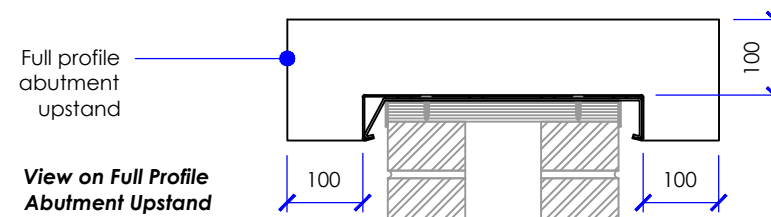
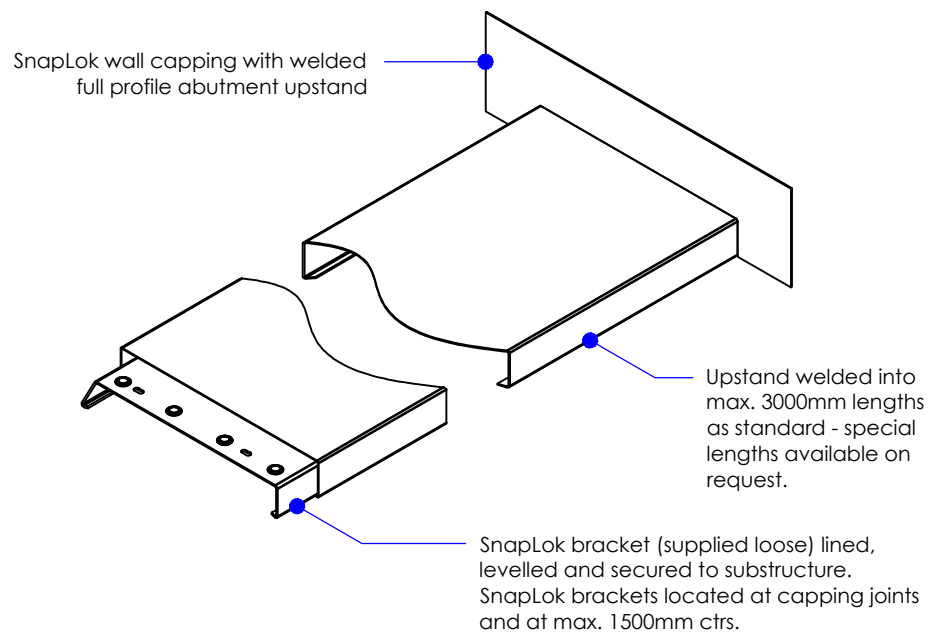

004 'SNAPLOK' WELDED FULL PROFILE ABUTMENT UPSTAND COMPONENT DETAIL
3 ISOMETRIC VIEW N.T.S.

004 'SNAPLOK' WELDED FULL PROFILE ABUTMENT UPSTAND COMPONENT DETAIL
4 VIEW ON PLAN SCALE 1 : 10

General Notes:

All dimension must be checked on site and any discrepancies reported to Guttermaster Ltd. prior to commencement of site work.
Do not scale from this drawing - use figured dimensions only.
This drawing remains the property of Guttermaster Ltd. and must not be copied or disclosed to a third party without prior consent.
If in doubt ask!

Assembly Recommendations:

P.V.C. isolating tape to be placed between dissimilar metal surfaces.
Use austenitic stainless steel fasteners with low profile heads where dissimilar metals are present - Supplier SFS Intec, Irius fixings.
Pre-drill holes for fixings. 1mm clearance around fixing to allow for expansion and thus prevent profile distortion.
Allow 1mm per metre expansion gap between profile lengths (e.g. 3mm gap between 3000mm profile lengths).
Apply low-modulus silicone sealant between union and profile.
For project specific requirements please contact Guttermaster Ltd.

GUTTERmaster			
ALUMINIUM IN CONSTRUCTION			
Shawclough Trading Estate, Shawclough Road, Rochdale, Lancashire, OL12 6ND		Tel: 01706 869550 Fax: 01706 869551 e-mail: technical@guttermaster web: www.guttermaster.co.uk	
Client: -			
Project: -			
Title: TYPICAL LAID LEVEL SNAPLOK CAPPING WELDED ABUTMENT DETAILS			
Drawing Status: ISSUE FOR INFORMATION			
Drawn by: A.S.	Checked by: -	Date: 01-03-2012	Approved by: -
Sheet size: A3	Scale: as shown	Sheet No. (of sheets): 1 (of 1)	Revision: -
		Drawing No: SL-01-004	

SnapLok capping with retaining bracket for use with insulated parapets and built up wall constructions. Details available on request.

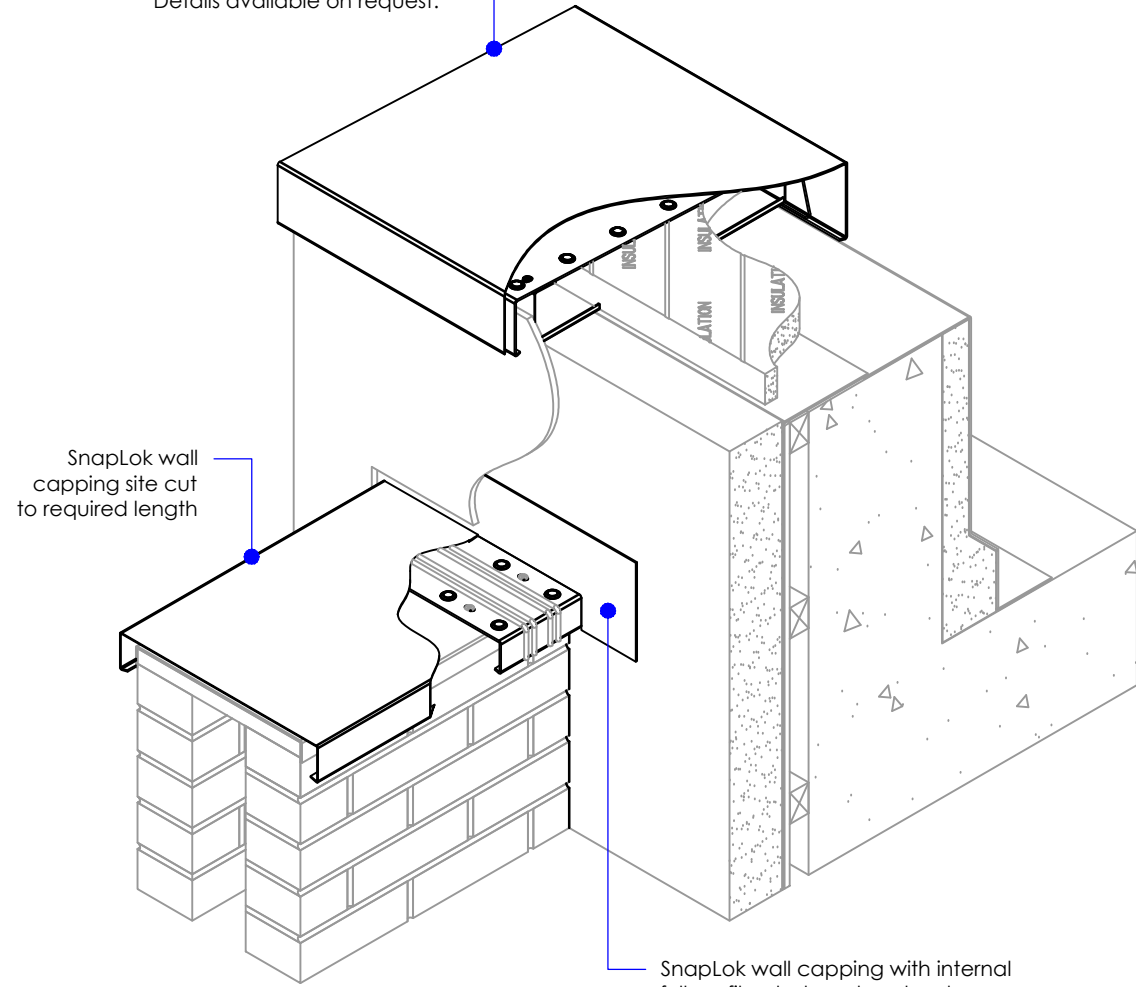

005 'SNAPLOK' INTERNAL FULL PROFILE ABUTMENT UPSTAND DETAIL
1 ISOMETRIC VIEW N.T.S.

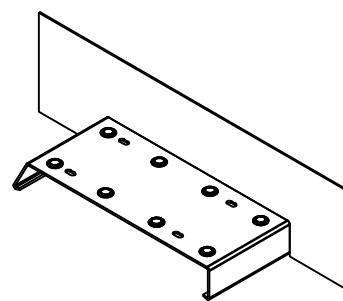

Full Profile Internal Abutment Upstand Component

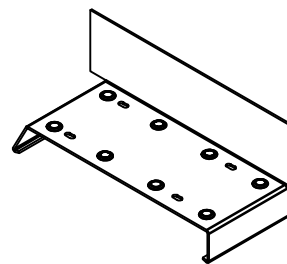

Top Face Internal Abutment Upstand Component

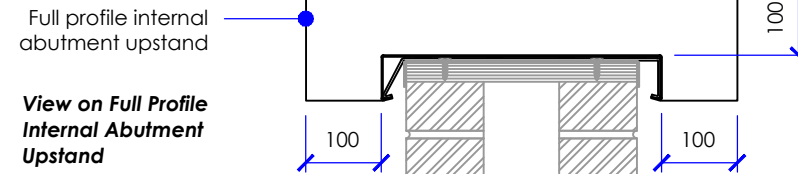

View on Full Profile Internal Abutment Upstand

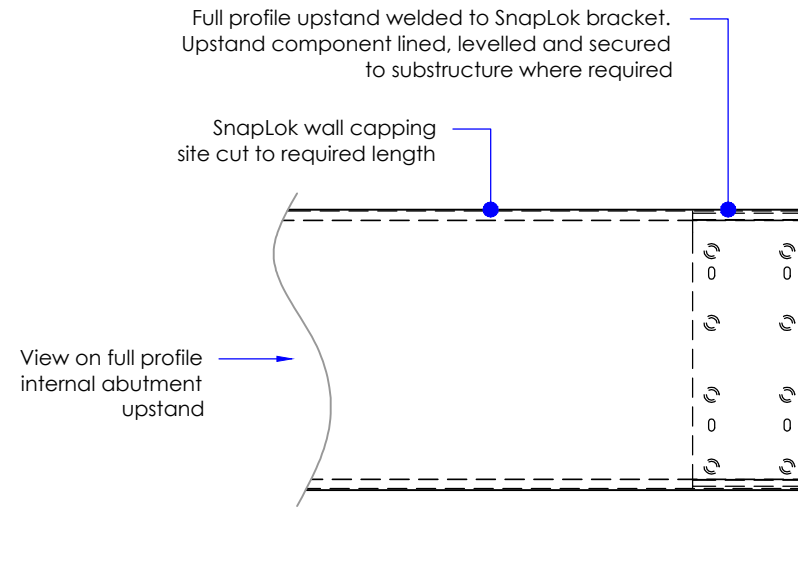

View on full profile internal abutment upstand

005 'SNAPLOK' INTERNAL FULL PROFILE ABUTMENT UPSTAND COMPONENT DETAIL
2 VIEW ON PLAN SCALE 1 : 10

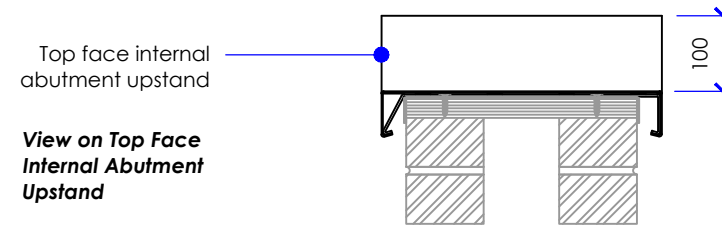

Top face internal abutment upstand

View on Top Face Internal Abutment Upstand

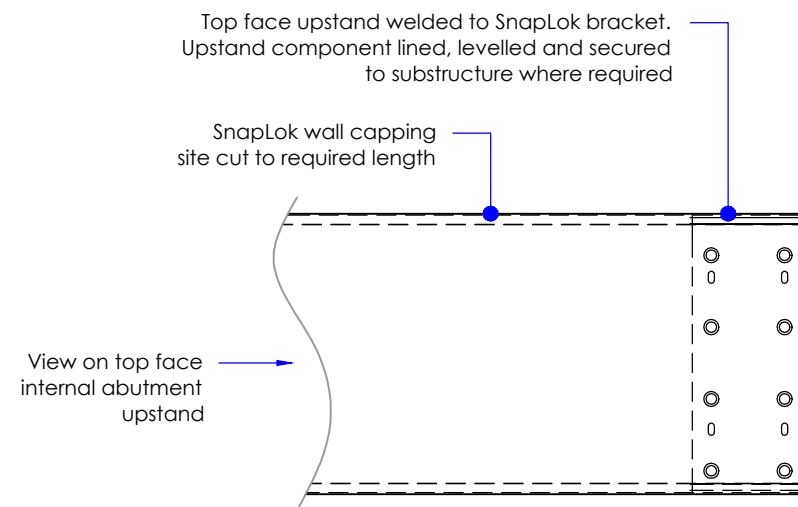

View on top face internal abutment upstand

005 'SNAPLOK' INTERNAL TOP FACE ABUTMENT UPSTAND COMPONENT DETAIL
3 VIEW ON PLAN SCALE 1 : 10

General Notes:

All dimension must be checked on site and any discrepancies reported to Guttermaster Ltd. prior to commencement of site work.
Do not scale from this drawing - use figured dimensions only.
This drawing remains the property of Guttermaster Ltd. and must not be copied or disclosed to a third party without prior consent.
If in doubt ask!

Assembly Recommendations:

P.V.C. isolating tape to be placed between dissimilar metal surfaces.
Use austenitic stainless steel fasteners with low profile heads where dissimilar metals are present - Supplier SFS Intec, Irius fixings.
Pre-drill holes for fixings. 1mm clearance around fixing to allow for expansion and thus prevent profile distortion.
Allow 1mm per metre expansion gap between profile lengths (e.g. 3mm gap between 3000mm profile lengths).
Apply low-modulus silicone sealant between union and profile.
For project specific requirements please contact Guttermaster Ltd.

GUTTERmaster				
ALUMINIUM IN CONSTRUCTION				
Shawclough Trading Estate, Shawclough Road, Rochdale, Lancashire, OL12 6ND		Tel: 01706 869550 Fax: 01706 869551 e-mail: technical@guttermaster web: www.guttermaster.co.uk		
Client: -				
Project: -				
Title: TYPICAL LAID LEVEL SNAPLOK CAPPING INTERNAL ABUTMENT DETAILS				
Drawing Status: ISSUE FOR INFORMATION				
Drawn by: A.S.	Checked by: -	Date: 01-03-2012	Approved by: -	Date: -
Sheet size: A3	Scale: as shown	Sheet No. (of sheets): 1 (of 1)	Drawing No: SL-01-005	Revision: -