

**EJOT® EJOBAR PVC****Best Practice  
and Installation Guide**

The Simple-Fix solution for reinforced PVC membrane roofs



# Using EJOT 'EJOBAR PVC' free-standing or fixed in position



For many applications where supporting an item that does not need to be restrained, EJOBAR can be used free-standing. For example, pipework between two fixed points, or where an intermediate support is required to maintain a static load above the roofing membrane.

For applications where an item needs to be restrained or secured to an approved reinforced PVC membrane, especially where resistance to uplift is required, EJOBAR should be hot air welded by a suitably qualified installer (see below).

Where extra fasteners are required a wind load calculation should be carried out to determine the required fixing centres. EJOT UK can provide this service.



## Simple to use and easy to install

EJOBAR can easily be installed to new or existing reinforced PVC single ply membrane roofs where approved by the specific membrane manufacturer.

The area that will receive the EJOBAR must be fully prepared and cleaned using water followed by a solvent cleaner specific to the PVC membrane being installed onto.

The EJOBAR can then be easily installed onto the membrane by hot air welding (by a suitably qualified and experienced installer) to the full perimeter of the EJOBAR firmly pressing the EJOBAR into place. Use a seam roller to ensure good all round adhesion to the membrane.



## Strength of weld and pull out performance

EJObar has been subjected to rigorous strength-of-weld tests at our Applitec Development and Testing Centre.

Here, eight leading reinforced PVC membranes were subject to a like for like programme of tensometer procedures. EJObar surpassed all reasonable criteria achieving an average Ultimate 3.8kN loading (loading can vary dependent upon the membrane type, therefore please consult EJOT Technical).

When on site, always check a sample weld first to ensure that the optimum weld temperature is set.

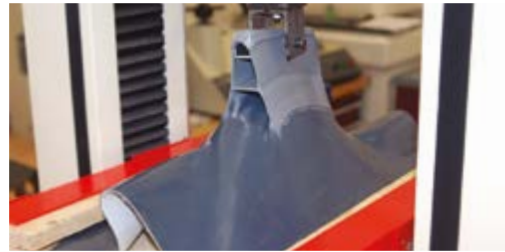

More than 20 PVC membranes have been subjected to rigorous testing by our Applitec team

## Maximum load point

The performance of the EJObar in the context of weight is dependent upon the construction of the roof and the compression performance of the insulation, as well as the position of the EJObar in relationship to the valley or crowns of any steel or Aluminum decking. Where it is fully supported and a uniformly distributed load is created, maximum load should be of 30 kg per/m.

**However, the roof construction must be checked by a structural engineer to ensure that these loadings can be accommodated.**



EJOT's EJOFast JF3-2-5.5 x 25 S16 Stainless steel Bi-Met fasteners also proved to be a clean efficient method of installing brackets and sections to the EJObar's 2mm aluminium box section.

The fastener's thread geometry displaces metal in contrast to a cutting drill action. Use of this fastener means that a secure installation with a pullout performance of over 3.6kN can easily be achieved. JF3 is available as either an 8mm A/F hexagon head or with a coloured Colorfast integral Nylon head. It is manufactured from A2 (1.4301) austenitic stainless steel with a hardened carbon steel pierce point.

EJOfast is also available as a JF6 variant, manufactured from A4 (316) Austenitic Stainless Steel if required for specific applications.



EJOT JF3 comes with European Technical Approval ETA-10/0200.

## 'EJOT EJOBAR PVC'

### Best Practice guide for hot air welding to reinforced PVC Membrane

The sequence below is based on the scenario where extra fixings and a membrane strap may be required. The commentary provides a best practice guide when hot air welding the EJOBAR system to approved PVC membranes.



**1**  
Accurately measure and mark out the EJOBAR installation area.



**2**  
Clean surface with appropriate solution as recommended by the membrane manufacturer.



**3**  
Apply correct fasteners for the application at centres determined by a Wind Load Calculation.



**4**  
Prepare Compatible membrane cover strap, rounding the ends, 100mm longer than the bar.



**5**  
Hot-Weld the membrane strap which should be 150mm in width to seal over the fixing line, taking pressure off the existing membrane



**6**  
Hot-weld EJOBAR in the centre of the reinforced membrane, directly over the line of fasteners.

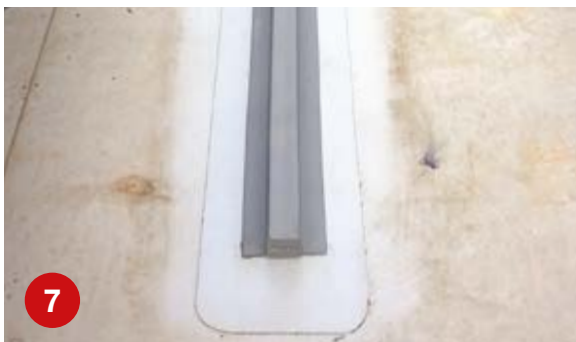

**7**  
How a single EJOBAR looks in position.



**8**  
How the completed system will look.

## General requirements for installation of solar and specialist applications

For specialist applications such as solar PV and thermal panels, the construction of the existing roof below the membrane, including the insulation layer needs to be checked. The membrane's suitability for lightweight system installation should be checked and approved first with the membrane manufacturer.



- The EJObar must extend 0.5m past the width of the panel system.
- The EJObar must extend the full length of the panel system.
- A support frame must be fixed on top of the EJObar prior to panel installation.
- Typically, for the external perimeter and corners, the bars should be positioned at a maximum of 500mm centres, and a maximum of 940mm in the inner field area.
- Only suitable for pitches up to 20 degrees, for pitches above 20 degrees please contact EJOT Technical.
- When the EJObar is to be installed away from a fixed side lap, a line of additional fasteners suitable for the application must be fixed where the EJObar system is to be positioned and a wind load calculation carried out to determine the required centres of those fasteners.

A strip of compatible reinforced membrane 150mm wide and a minimum of 1.5mm thick, should then be hot air welded over the top of the fasteners for the EJObar to sit on.

If the original membrane has been adhered only, then the above procedure must happen with every EJObar that is installed.

- The membrane roof needs to be checked by an engineer for suitability for the additional loadings of a solar system.
- The EJObar needs to be laid in the same direction of the roof fall rather than across the slope to avoid any ponding of rainwater.
- When on site, always undertake a sample weld first to ensure that the optimum weld temperature is set.

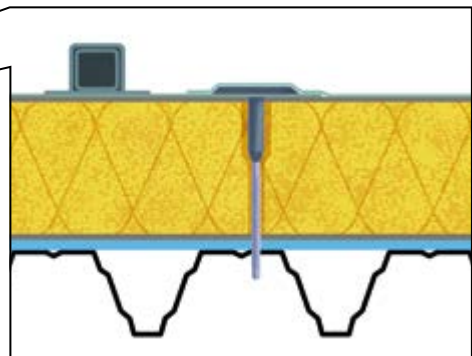
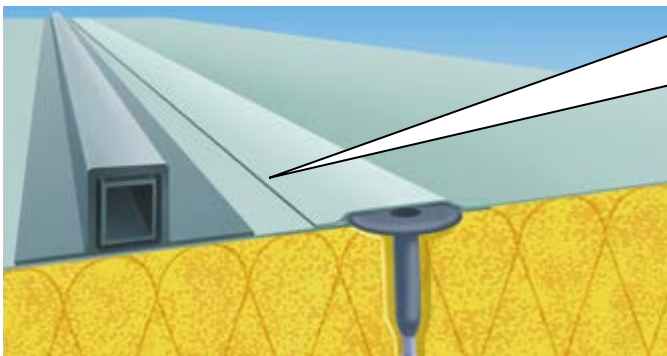

The EJObars can be positioned within the field area of the membrane or adjacent and parallel with the seam as shown here. The EJObars must not be secured above the seam and fixing line or be positioned across the seam.

If the application and the orientation of the bars prevent them from being positioned next to the seam, a 150mm wide of 1.5mm minimum thickness strip of PVC compatible reinforced membrane will need to be installed with a 40mm weld to all sides.

Additional fasteners may be required depending on the results of a wind load calculation and will be essential where the membrane is an adhered system. The EJObars can then be installed onto this strip.

Please refer to 'General requirements for installation of solar and specialist applications' on the centre pages of this information guide.



Do not install EJObars over the seam, without using an additional membrane cover strip.



EJObars positioned correctly over membrane strip.

## 1 metre cover width: field area

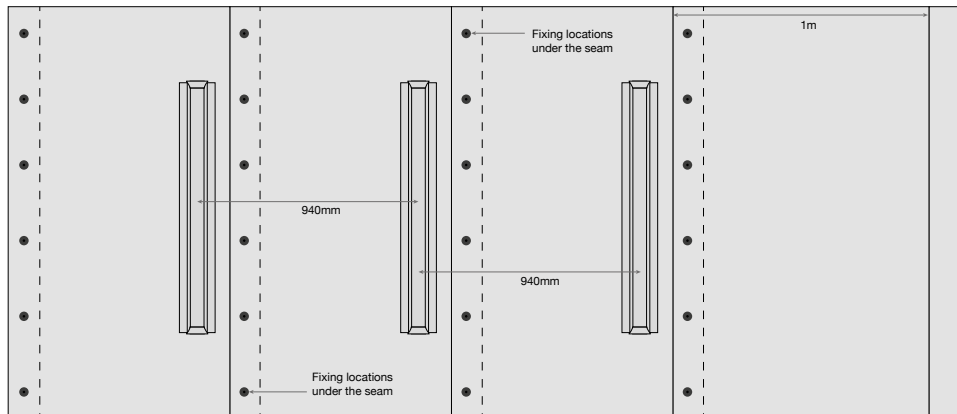

## 1 metre cover width: corner or perimeter areas

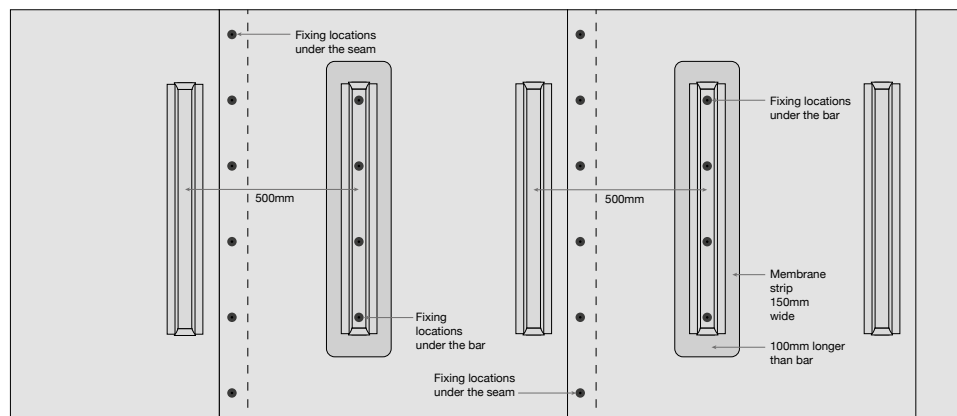

## 2 metre cover width: field area

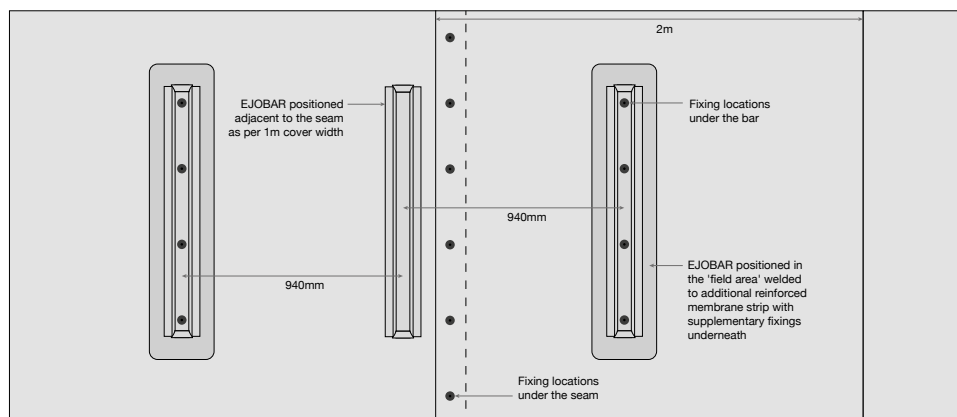

## 2 metre cover width: corner or perimeter areas

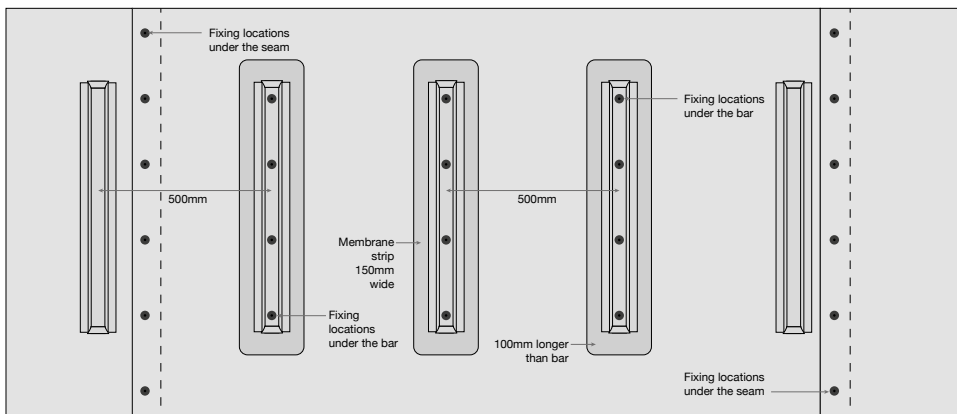

Drawings are not to scale

**For less standard membrane widths or unusual application requirements please call EJOT Technical Support on (+44) 1977 68 70 40.**

## Available in practical lengths

**EJOBAR** is available in 0.3m or 0.5m lengths for mechanical & electrical applications, and 1.0m or 3.0m for PV solar installations.

Talk to EJOT UK Customer Service or visit the EJOT UK webshop for more details.

### For Mechanical applications use

EJOBAR PVC 300mm

EJOBAR PVC 500mm

### For Solar applications use

EJOBAR PVC 1000mm

EJOBAR PVC 3000mm



### EJOT UK Limited

Hurricane Close, Sherburn Enterprise Park,  
Sherburn-in-Elmet, Leeds LS25 6BP

Tel: (+44) 1977 68 70 40

Email: [info@ejot.co.uk](mailto:info@ejot.co.uk)

[www.ejot.co.uk](http://www.ejot.co.uk)



**EJOT®** The Quality Connection

V3-April-2020

**EJOT®**