

Recommendations for the Installation of Profab Access **PRIMA 1000 Series** Access Panels



» CONTACT US

Profab Access, Riversdale House, Units C-D Riversdale Road,
Carlyon Road Industrial Estate, Atherstone, Warwickshire CV9 1FA, UK

Sales Enquiries: +44(0) 1827 718 222 sales@profabaccess.com

Technical Enquiries: +44(0) 1827 719 051 technical@profabaccess.com







www.profabaccess.com

Profab Access is part of the Access 360 division of Tyman UK & Ireland.

SAFE ACCESS ALL AREAS



» CONTENTS

Handling, storage & protection		P3
Handling		P3
Storage		P3
Protection		P3
Before You Start		P4
Opening		P4
Installation		P4
Clearances		P4
Adjusting Door Sizes		P4
Apertures		P4
Frame Packer Materials Requirements		P4
Fixings		P4
Tools & Components Required		P5
Door Finishes		P5
Picture Frame (PF) with Metal Door (MD)		P5
Beaded Frame (BF) with Metal Door (MD)		P6
Plastering a Beaded Frame (BF)		P7
Beaded Frame (BF) with Plasterboard Door (PD)		P8
Mastic/Silicone Seals		P9
Locks	  	P10
Locking Options		P10
Caps & Bungs		P10
Keys		P11



» CONTACT US

Profab Access, Riversdale House, Units C-D Riversdale Road,
Carlyon Road Industrial Estate, Atherstone, Warwickshire CV9 1FA, UK

Sales Enquiries: +44(0) 1827 718 222 sales@profabaccess.com

Technical Enquiries: +44(0) 1827 719 051 technical@profabaccess.com

www.profabaccess.com

Profab Access is part of the Access 360 division of Tyman UK & Ireland.

SAFE ACCESS ALL AREAS



» HANDLING STORAGE & PROTECTION

Handling

- Profab Access's riser doors and doorsets are high quality products and therefore require an appropriate level of protection on site. We recommend the packaging should not be removed until immediately before the doorsets are ready to be installed.
- Our products can be heavy so please take extra care to avoid damage to the product and prevent injury to site personnel. Always work in accordance with each site's manual handling policy.
- Our products are designed for forklift truck off-loading and will be supplied wrapped in stacks for ease of distribution.

Storage

The correct storage conditions for Profab Access's products is essential to ensure the product performs and appears as specified. Storage and protection of the products on site is the responsibility of the contractor. Profab Access's products should be stored close to the final installation area or in a location with limited access and traffic.

DO NOT

- **Store on panel/frame edge.**
- **Store directly on the floor.**
- **Store near heaters.**
- **Stack product lent against walls.**
- **Stock product over 1 metre high.**
- **Store other product on top of the stored panels.**
- **Restack panels after delivery without using the same material or method to that used while the products were being transported.**

Protection

Bespoke panels

These are supplied with installed Protek protection and is applied to allow the door to function after installation (not applicable to Plaster Board panels or tiled panels). The product is then wrapped in shrink wrap to protect the product during transportation. It is essential to protect the doorset's after they are installed until the handover of the building. Protek will protect the door facings and will give basic protection from paint and dirt etc, the Protek will not protect the doors from impacts and it is the responsibility of the contractor's to assess the level of protection required for the panel and provide it. When reapplying the Protek or applying other types of protection a low tack adhesive tape should be used, do not use any form of packing tape or duck types of tape as this may damage the powder coating finish and mark the doorsets.

Stock panels

These are supplied boxed with no additional protection, add protection after installation as required. Additional low tack tape can be purchased, please contact a member of the Profab Access team. It is recommended that a box knife is used to remove the transport protection as an open blade may scratch/damage the product.

» CONTACT US

Profab Access, Riversdale House, Units C-D Riversdale Road,
Carlyon Road Industrial Estate, Atherstone, Warwickshire CV9 1FA, UK

Sales Enquiries: +44(0) 1827 718 222 sales@profabaccess.com

Technical Enquiries: +44(0) 1827 719 051 technical@profabaccess.com

www.profabaccess.com

SAFE ACCESS ALL AREAS



» BEFORE YOU START

Opening

- Make sure that you have the correct panel/doorset in relation to the opening in which it is going to be installed; each product has a unique reference located on the label (Door Number), which links with the contract drawings and schedules.
- Check the structural opening is plumb and level before you start installation. Our product is designed to allow for an opening to be no greater than 5mm out of square.
- Before removing the packaging check that the overall dimensions of the panel will fit the opening it is intended for, if correct remove the transport packaging and take care to retain any loose items.

» INSTALLATION

Clearances

The following clearances should be achieved around the panel when closed to comply with fire certification and for the product to function correctly.

- Frame to door gap = 3mm maximum (Manufactured to allow 2mm)
- Meeting Stiles gap = 3mm maximum (Manufactured to allow 2mm)
- Structural opening to frame gap = 5mm allowance

Adjusting panel sizes

All of our panels are made to measure and cannot be cut down or adjusted. It is recommended that the structural openings are measured prior to the panels being manufactured.

Apertures

No site cutting of any type of aperture is permitted.

Frame packer material requirements

- Non-fire rated – any type of plastic, timber or metal packers.
- Fire rated – to ensure the integrity of the fire performance of the door set, steel packers or a non-combustible material must be used.

Fixings

- For masonry or concrete: Profab Access's doorsets must be installed using a minimum M6 steel anchor fixings.
- For plasterboard wall assemblies: Profab Access's doorsets must be installed using a minimum No 6 plasterboard screws (steel) or steel woodscrews.

» CONTACT US

Profab Access, Riversdale House, Units C-D Riversdale Road,
Carlyon Road Industrial Estate, Atherstone, Warwickshire CV9 1FA, UK

Sales Enquiries: +44(0) 1827 718 222 sales@profabaccess.com

Technical Enquiries: +44(0) 1827 719 051 technical@profabaccess.com

www.profabaccess.com

Profab Access is part of the Access 360 division of Tyman UK & Ireland.

SAFE ACCESS ALL AREAS



Tools & components required

- Battery or mains drill or screw driver, suitable for masonry walls if applicable.
- Basic hand tools.
- Various length spirit level dependent on the panel size, it is advised that a suitable length spirit level is used for the panel which is being installed. e.g. it is not recommended to use a 300mm level on a 1800mm long frame section.
- Frame packers (if applicable)

» DOOR FINISHES

All steel components of the panel and frame are supplied with a powder coat finish (white). This finish can be the finished item with no additional finish required or can be painted over to match other wall finishes.

When painting the panels the powder coat will require a light sand/de-nibbing, this will key the paint to the powder coat.

If in doubt or if there are any questions, please contact a member of the Profab Access technical team on 01827 719 051 or email technical@profabaccess.com

» PICTURE FRAME (PF) WITH METAL DOOR (MD)

- Ensure opening is level and plumb and that the opening is around 5mm larger than the frame.
- Position the frame into the opening and sit the bottom frame section on a couple of 2mm packers.
- Using 2 of the frame countersunk fixing locations, preferably the top fixing points on each side.
- Loosely install the frame.
- Add further packers around the remaining 3 sides making sure the frame is equally spaced and allowing the panel to close with an equal gap between the panel and frame.
- Before inserting the remaining fixings ensure the locking device can locate into the frame and lock.
- Insert the remaining fixings, ensure all fixings holes are used.



Note, during the installation process the door may need removing on larger panels, this can be done by removing the 2 screws within the panel, 1 at the top pivot point and 1 at the bottom pivot point. It is recommended that this be done with a long reach manual screw driver and not with a battery operated screw driver to eliminate any cross threading. On fire rated panels it may be necessary to remove the silver foil and Rockwool to gain access to the screws. Ensure the Rockwool and foil is replaced to ensure the fire integrity is not affected.

» CONTACT US

Profab Access, Riversdale House, Units C-D Riversdale Road,
Carlyon Road Industrial Estate, Atherstone, Warwickshire CV9 1FA, UK

Sales Enquiries: +44(0) 1827 718 222 sales@profabaccess.com

Technical Enquiries: +44(0) 1827 719 051 technical@profabaccess.com

www.profabaccess.com

» **BEADED FRAME (BF) WITH METAL DOOR (MD)** 

- Ensure opening is level and plumb and that the opening is around 5mm larger than the frame.
- Position the frame into the opening and sit the bottom frame section on a couple of 2mm packers.
- Using 2 of the frame countersunk fixing locations, preferably the top fixing points on each side.
- Loosely install the frame.
- Add further packers around the remaining 3 sides making sure the frame is equally spaced and allowing the panel to close with an equal gap between the panel and frame.
- Before inserting the remaining fixings ensure the locking device can locate into the frame and lock.
- During the installation process the door may need removing on larger panels, this can be done by removing the 2 screws within the panel, 1 at the top pivot point and 1 at the bottom pivot point. It is recommended that this be done with a long reach manual screw driver and not with a battery operated screw driver to eliminate any cross threading.
- On fire rated panels it may be necessary to remove the silver foil and Rockwool to gain access to the screws. Ensure the Rockwool and foil is replaced to ensure the fire integrity is not affected.
- Insert the remaining fixings, ensure all fixings holes are used.
- It is good practice on a beaded frame to add fixings to the face of the frame. Ensures the fixings do not protrude passed the face of the bead.

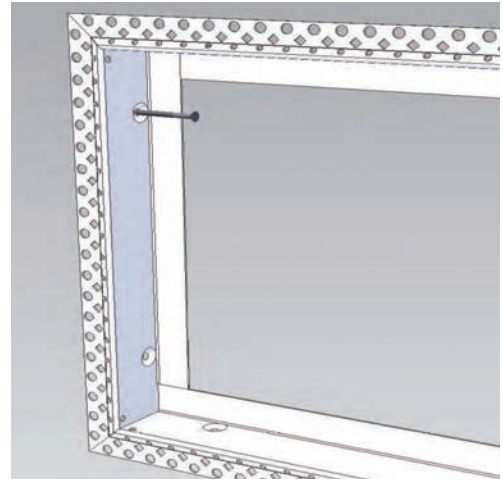

Loosely fix frame

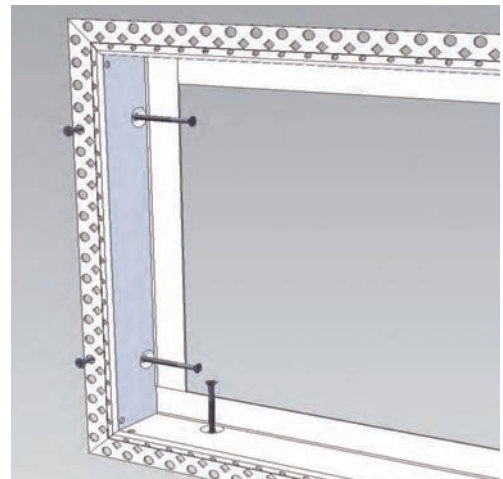

Add remaining fixings

» **CONTACT US**

Profab Access, Riversdale House, Units C-D Riversdale Road,
Carlyon Road Industrial Estate, Atherstone, Warwickshire CV9 1FA, UK

Sales Enquiries: +44(0) 1827 718 222 sales@profabaccess.com

Technical Enquiries: +44(0) 1827 719 051 technical@profabaccess.com

www.profabaccess.com

Profab Access is part of the Access 360 division of Tyman UK & Ireland.

SAFE ACCESS ALL AREAS



» PLASTERING A BEADED FRAME

- Spread finish coat plaster (skimming) or jointing compound (tape & Jointing) along the bead overlapping onto the plasterboard surface. 'Bed in' paper joint tape by pressing it firmly into the plaster/ jointing compound material.

Note, Paper tape is preferred to self-adhesive fibre tape as it generally considered to give better resistance to cracking.

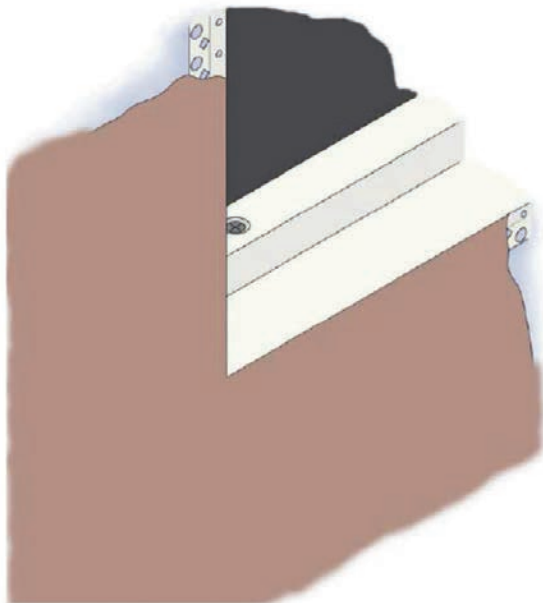
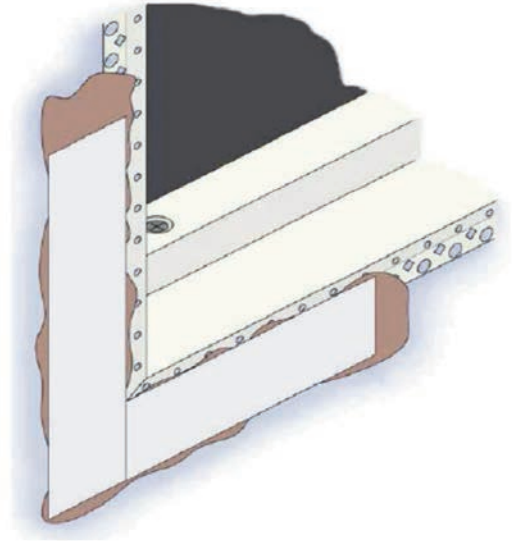

- Plaster skimming – Trowel apply finish coat plaster ensuring the paper tape remains positioned and that the plaster is pushed through the tape well into any gaps between the beaded frame and the plasterboard surface. Finish the skimming with a firm pressure to the beaded frame joint after the joint treatment has stiffened but not set.
- Taping and jointing – Trowel apply 2 or 3 applications of jointing compound allowing each to set dry before the next application, feathering each out beyond the previous application. Sand as required to achieve a smooth surface.

- Remove any excess plaster that may have fallen between the frame and panel.
- If plastering the frame while the panel is installed ensure the gap between the frame and panel is free from plaster or jointing compound. Plaster/jointing compound within the gap may result in the panel being damaged during operation.

» CONTACT US

Profab Access, Riversdale House, Units C-D Riversdale Road,
Carlyon Road Industrial Estate, Atherstone, Warwickshire CV9 1FA, UK

Sales Enquiries: +44(0) 1827 718 222 sales@profabaccess.com

Technical Enquiries: +44(0) 1827 719 051 technical@profabaccess.com

www.profabaccess.com

Profab Access is part of the Access 360 division of Tyman UK & Ireland.

SAFE ACCESS ALL AREAS



» **BEADED FRAME (BF) WITH PLASTERBOARD DOOR (PD)** 

Follow the frame installation instructions as details within the **BEADED FRAME (BF) WITH METAL DOOR (MD)** section of this guide.

- To assist in plastering the panel it is recommended to remove the panel before plastering. This also eliminates any build-up of plaster between the frame and panel which could affect the operation of the panel.
- During plastering ensure any lock holes are free from plaster.

To remove the panel

- Open the panel
- On the reverse of the panel there is a plate that is sprung, push this towards the hinge edge as shown below.
- This will expose the top and bottom pivot pin.
- Once the pin is exposed slide the panel toward the frame un-locating the pivots out of the panel, the panel can now be pulled out of the frame.
- Re-fitting of the panel is a reverse of this process.

Note, larger panels may need 2 people to assist in the removal.



Open the panel



Pin un-exposed



Pin exposed

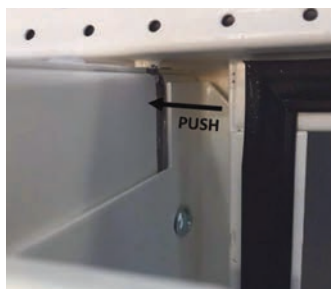

Push panel towards the frame



Remove pivot from panel and pull panel out of frame

If in doubt or if there are any questions please contact a member of the Profab Access Team

» **CONTACT US**

Profab Access, Riversdale House, Units C-D Riversdale Road,
Carlyon Road Industrial Estate, Atherstone, Warwickshire CV9 1FA, UK

Sales Enquiries: +44(0) 1827 718 222 sales@profabaccess.com

Technical Enquiries: +44(0) 1827 719 051 technical@profabaccess.com

www.profabaccess.com

Profab Access is part of the Access 360 division of Tyman UK & Ireland.

SAFE ACCESS ALL AREAS



» MASTIC/SILICONE SEALS

- Non Fire rated doorsets, it is advised that a mastic or silicone sealant is applied around the rear perimeter of the frame. Any type of Mastic, silicone sealant can be used dependent on the client's requirements.
- Fire Rated doorsets, it is essential for a fire rated mastic be applied to the rear perimeter of the frame. The fire rated mastic should have a fire rating to match that of the doorset.
- Ensure that the mastic is of an equal or higher fire rating of the panel and that it is fire rated to be used on a steel panel/doorset.

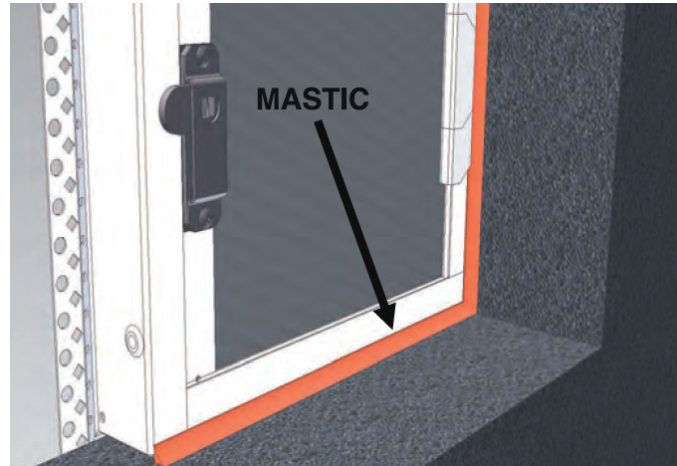

» CONTACT US

Profab Access, Riversdale House, Units C-D Riversdale Road,
Carlyon Road Industrial Estate, Atherstone, Warwickshire CV9 1FA, UK

Sales Enquiries: +44(0) 1827 718 222 sales@profabaccess.com

Technical Enquiries: +44(0) 1827 719 051 technical@profabaccess.com

www.profabaccess.com

Profab Access is part of the Access 360 division of Tyman UK & Ireland.

SAFE ACCESS ALL AREAS



» LOCKING OPTIONS 

There are a number of different locking options, all locks are installed and set during the manufacturing process with no need for adjustment once on site.



Push Catch (PC)
(Non-fire rated products only)



Budget Lock (BL)

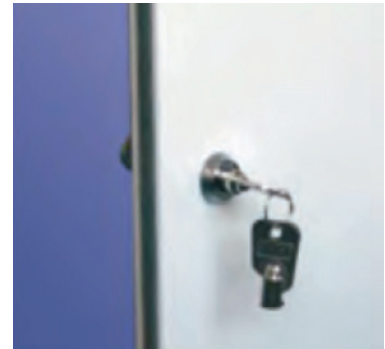

Security Lock (SL)

» CAPS AND BUNGS

There are 2 main types of caps and bungs, 1 is designed for the Plaster Board (PD) Door and the second one is designed for the Metal Door (MD)

These are supplied installed into the panels during the manufacturing process, extra/spare caps and bungs can be purchased.

**For more information,
please contact a member
of the Profab Access Team.**



Plaster Board Bung installed



Plaster Board Bung Removed



Metal Door Cap & Collar installed



Metal Door Cap removed,
Collar exposed

» CONTACT US

Profab Access, Riversdale House, Units C-D Riversdale Road,
Carlyon Road Industrial Estate, Atherstone, Warwickshire CV9 1FA, UK

Sales Enquiries: +44(0) 1827 718 222 sales@profabaccess.com

Technical Enquiries: +44(0) 1827 719 051 technical@profabaccess.com

www.profabaccess.com

Profab Access is part of the Access 360 division of Tyman UK & Ireland.

SAFE ACCESS ALL AREAS



» HANDLING STORAGE & PROTECTION

Keys

All 'T' bar keys and or Security lock keys are supplied with the panels, please be careful when unpacking the panels not to discard these.

Additional 'T' bar keys can be purchased, please contact a member of the Profab Access Team.



» CONTACT US

Profab Access, Riversdale House, Units C-D Riversdale Road,
Carlyon Road Industrial Estate, Atherstone, Warwickshire CV9 1FA, UK

Sales Enquiries: +44(0) 1827 718 222 sales@profabaccess.com

Technical Enquiries: +44(0) 1827 719 051 technical@profabaccess.com

www.profabaccess.com

Profab Access is part of the Access 360 division of Tyman UK & Ireland.

SAFE ACCESS ALL AREAS



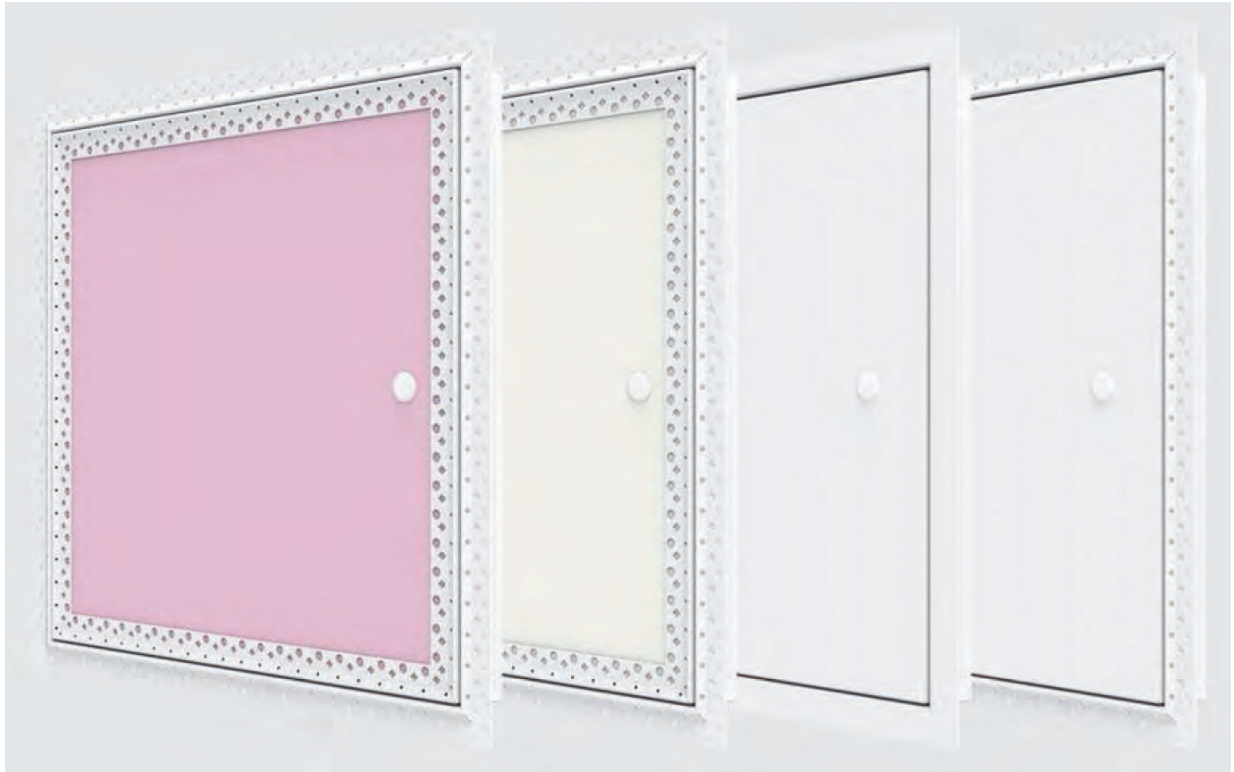

» CONTACT US

Profab Access, Riversdale House, Units C-D Riversdale Road,
Carlyon Road Industrial Estate, Atherstone, Warwickshire CV9 1FA, UK

Sales Enquiries: +44(0) 1827 718 222 sales@profabaccess.com

Technical Enquiries: +44(0) 1827 719 051 technical@profabaccess.com

www.profabaccess.com

Profab Access is part of the Access 360 division of Tyman UK & Ireland.

SAFE ACCESS ALL AREAS

