

CLARK-DRAIN



THE DRAINAGE COMPANY

CHAMBER ACCESS SYSTEMS FOR TRAFFIC SIGNALS, STREET LIGHTING AND COMMUNICATION NETWORKS

PRODUCT SELECTION & SPECIFICATION GUIDE

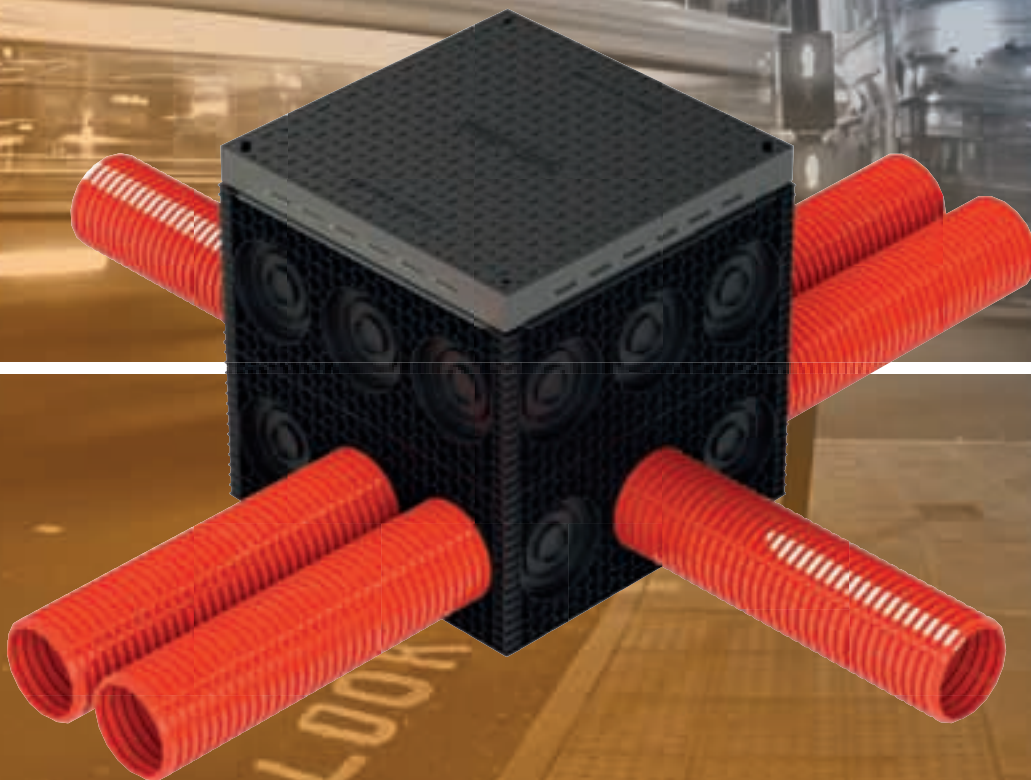

Access Chamber Systems

For traffic signals, street lighting and communication networks

FEATURES

- 1 Pre-trepanned duct/pipe entries
- 2 Sliding T-Slot corner connections for ease of assembly and leveling
- 3 Sections clip together for easy site assembly and to aid alignment for stacking
- 4 The honey comb internal wall provides natural structural strength - the honey comb wall pattern enables a concrete surround to flow into voids, adding to the structural strength of the system
- 5 B125 composite cover complete with galvanised steel louvre design frame
- 6 Horizontal cutting lines marked on the inside face of each panel ease 50mm or 75mm height reduction
- 7 Chamber panels are injection moulded in 100% recycled polypropylene and are recyclable at end-of-life

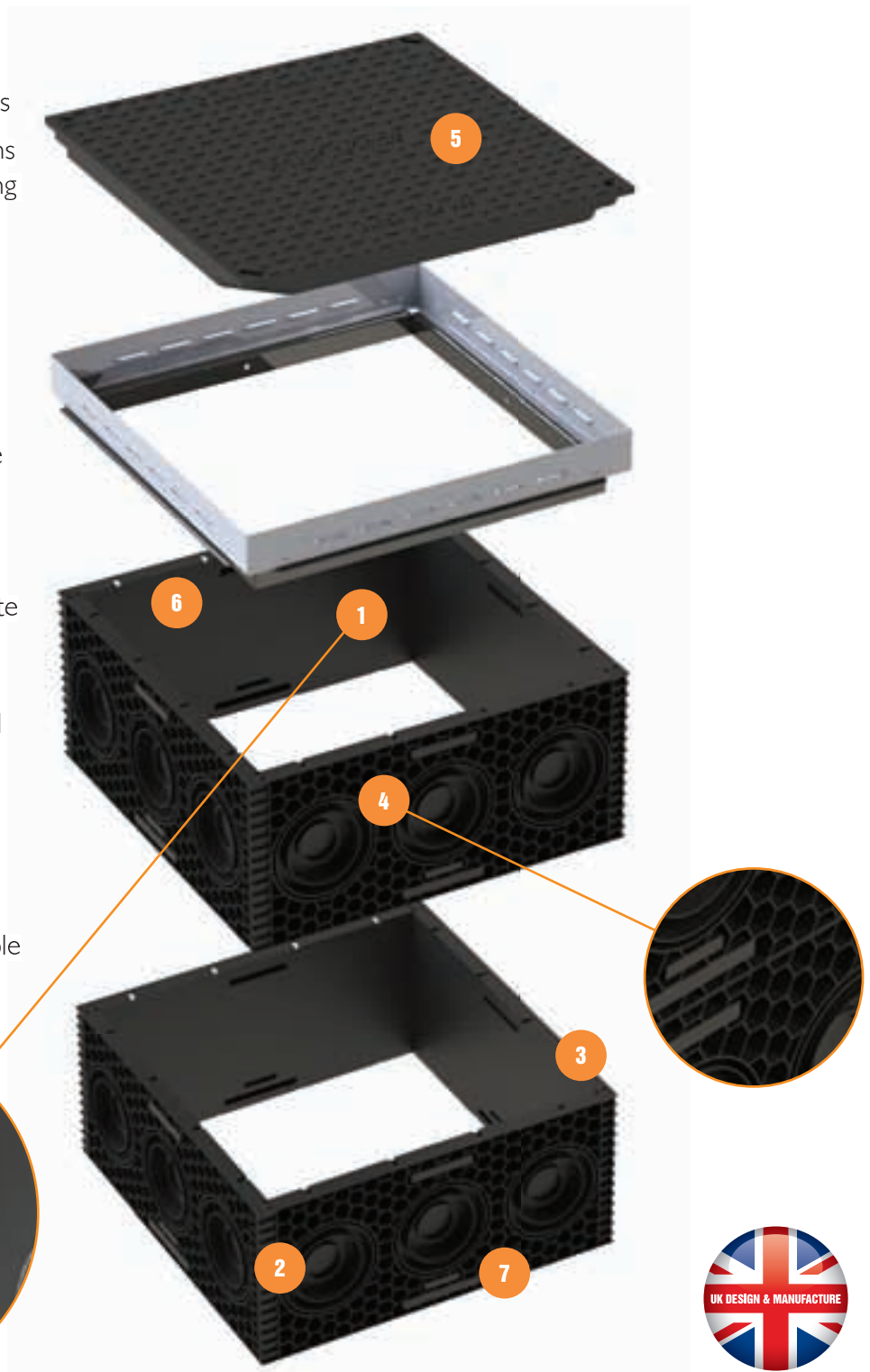



Flat panel chamber assemblies are used frequently in construction, especially for utility installations, to ease and protect access to ducting and underground services.



Project Suitability

- Pavements
- Road verges
- Street lighting
- Traffic signalling

CHAMBER ACCESS

Easy assembly of components to clear opening sizes:

- 300mm x 300mm
- 450mm x 300mm
- 450mm x 450mm
- 600mm x 450mm
- 600mm x 600mm

How it works

Reliability through material choices and design is necessary to ensure optimal safety, longevity, and strength, hence the honeycomb pattern combining light-weight construction materials with high-strength qualities.

The chamber access system uses sections which clip together for easy site assembly and to aid alignment for stacking.

There are also pre-trepanned locations to accept 63mm, 110mm, 120mm and 160mm diameter duct with a 178mm indentation for larger specifications. These are designed to help guide the operator and installer to accommodate various duct types.

Specification considerations

- B125 load rating classification
- Light weight
- Panels available in 300mm, 450mm and 600mm widths (300mm high)
- The chamber is designed to support the Specification for Highway Works relating to the minimum depths of excavation for duct laid under verges, footways or open ground
- All quality systems and inspection procedures comply with BS EN ISO 9001:2008
- Chambers can be stacked 1, 2, 3 or 4 units high

Typical Installations

Panels are 300mm deep, with interlocking features which allow multiple panels to be assembled, easily stacked and installed to the recommended depths and positioning of underground utilities. Any size panel can be joined to any other to make the combinations of clear opening sizes mentioned.

Product code	Panel Width (mm)	Panel Depth (mm)	Total weight (kg)
CD 251	300	300	0.6
CD 252	450	300	0.8
CD 253	600	300	1.0

Composite covers

Lightweight, high quality composite covers for easy and safe manual removal are ideal for access to sewage systems, underground pipework, electrical ducting and communication networks. The covers are available as a B125 load rating with a galvanised steel frame.

Specification considerations

- B125 load rating classification.
- Many manhole applications require manhole lids to be non-conductive. For Telecommunication and electrical utility applications the covers are non-ferrous composite material. Covers are black in colour and marked "Clark-Drain" with "Traffic signalling" or "Street Lighting" badging.
- A slip resistant cover with a PSRV value of 60 suits both low risk pedestrian traffic, cyclists or equestrian use and potentially high risk sites, specified (Part 5 HA 104/09).
- Composite material is resistant to chemicals and is not subject to rust and corrosion.
- Composite covers are secured inside the chamber by a vertical flange which provides height and tilt adjustment at surface level.
- Frames are galvanised to BS EN 1461.
- Composite material has no scrap value acting as a theft deterrent.

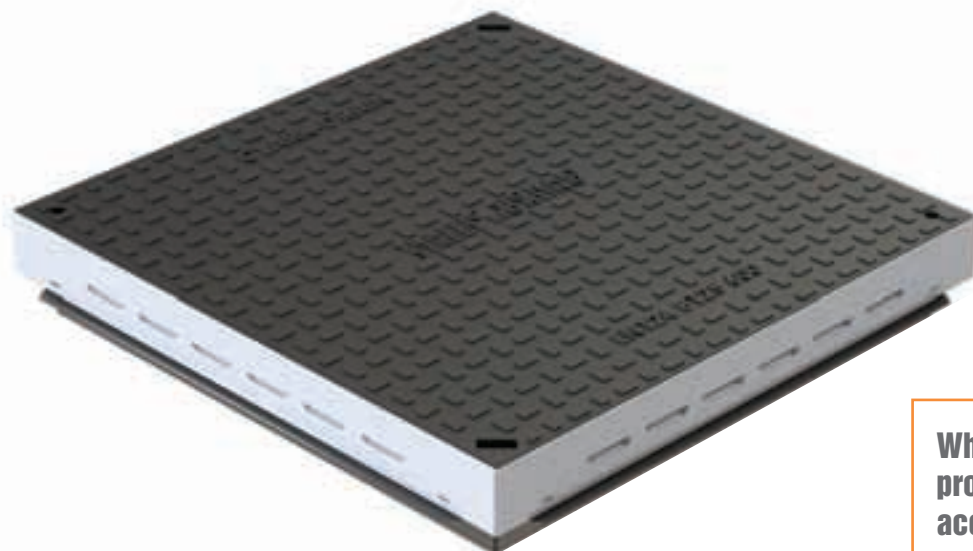

Whether a new build or renewal project, Clark-Drain's range can accommodate utility access construction for the following applications:

- **Electricity**
- **Cable TV/CCTV**
- **Gas**
- **Water**
- **Telecommunications**

FEATURES

- 1 Captive cage nut for fixing lid to frame using 2 stainless steel cap-head screws per lid
- 2 Badging as standard 'TRAFFIC SIGNALS' / 'STREET LIGHTING'
- 3 Cover cap for keyholes to reduce dust/debris ingress
- 4 Multi-purpose louvre frame with 70mm up stand to accommodate a variety of surface materials, e.g. up to 65mm paving blocks, paving slabs, tarmac, resin gravel and concrete, etc.
- 5 Bolt holes to secure frame to chamber
- 6 Integral lifting key holes to suit long handle lifting key CD 553L (available separately)

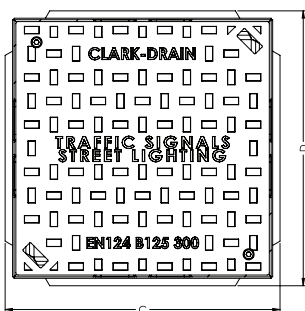
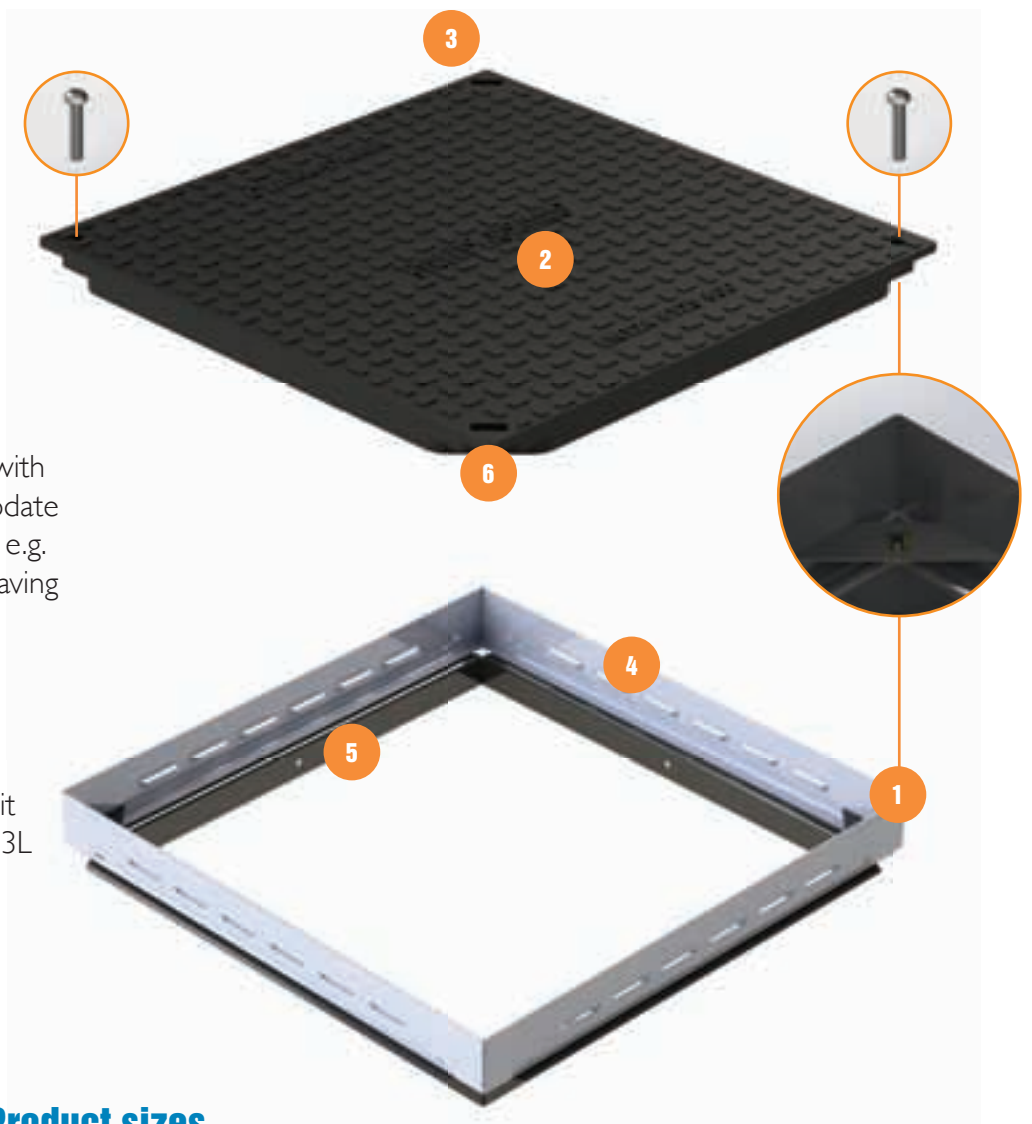

Product sizes

Access covers are specified by their clear opening dimensions (A x B), depth (E) and overall size (C x D). The product sizes indicated in the table below are referenced in the diagram.

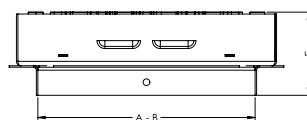

Product code	BS EN 124 loading class	Description	Clear opening size (mm) A x B	Overall size (mm) C x D	Overall depth (mm) E	Total weight (Kg)
CD 261/SF	B125	Composite cover with galvanised steel frame	300 x 300	369 x 369	120	10
CD 262/SF	B125	Composite cover with galvanised steel frame	450 x 300	519 x 369	120	13
CD 263/SF	B125	Composite cover with galvanised steel frame	450 x 450	519 x 519	120	17
CD 264/SF	B125	Composite cover with galvanised steel frame	600 x 450	669 x 519	120	21
CD 265/SF	B125	Composite cover with galvanised steel frame	600 x 600	669 x 669	120	28

Options

- Resistorx security bolt for fixing lid to frame
- Other products available include heavy duty D400/E600 chambers with ductile iron covers

Installation Guide

CLARK-DRAIN B125 MODULAR CHAMBER INSTALLATION GUIDELINES

THESE ARE INTENDED AS GUIDELINES ONLY – IF IN DOUBT, SEEK ADVICE.
ALWAYS TAKE CARE WHEN USING HAND AND POWER TOOLS AND WEAR PPE.

Notes before starting works:

a) Clark-Drain B125 modular chamber panels are supplied with a selection of pre-trepanned duct entries on the outside faces of the panels, and markings/pilot drill guides on the inside faces for further duct entry size and spacing options. All are marked with the sizes of either 63mm, 110mm, 120mm, 162mm or 178mm, although the exact selection available depends on the panel size (300, 450 or 600mm) concerned.

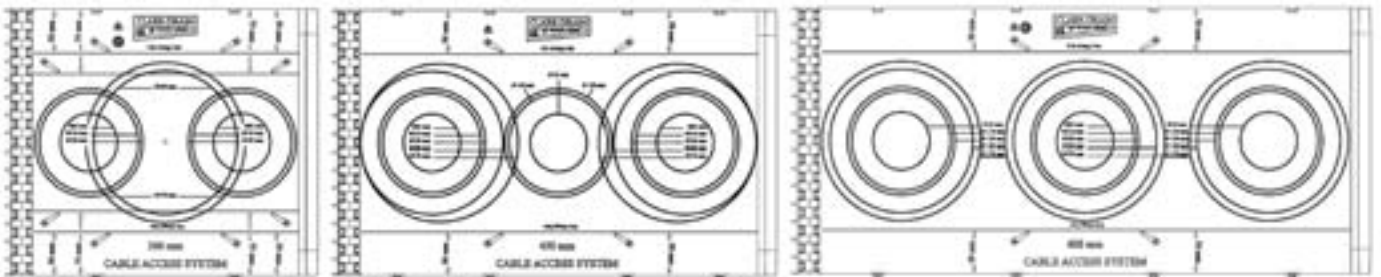

- b) Once the required duct entry sizes and configuration is decided, they should be drilled using an appropriately sized hole saw. Duct entries should **not** be drilled at positions other than those that are pre-marked on the chamber panel.
- c) All ducting should enter at 90° to the chamber wall.
- d) Chamber panels are supplied unassembled and can be used in any configuration of the 300, 450 and 600mm versions available to create either 300x300, 450x300, 450x450, 600x450 or 600x600 chambers.
- e) Standard panel depth is 300mm, and panels can be stacked on top of each other and clipped together to create chamber depths of 300, 600, 900 or 1200mm. It is not recommend to exceed 1200mm depth.
- f) Should fine-tuning of chamber depth be required, each chamber panel is moulded with an integral cutting line guide at 50 and/or 75mm from the top or bottom edge. A hand saw can be used to remove the required amount and adjust the finished height of the chamber installation.

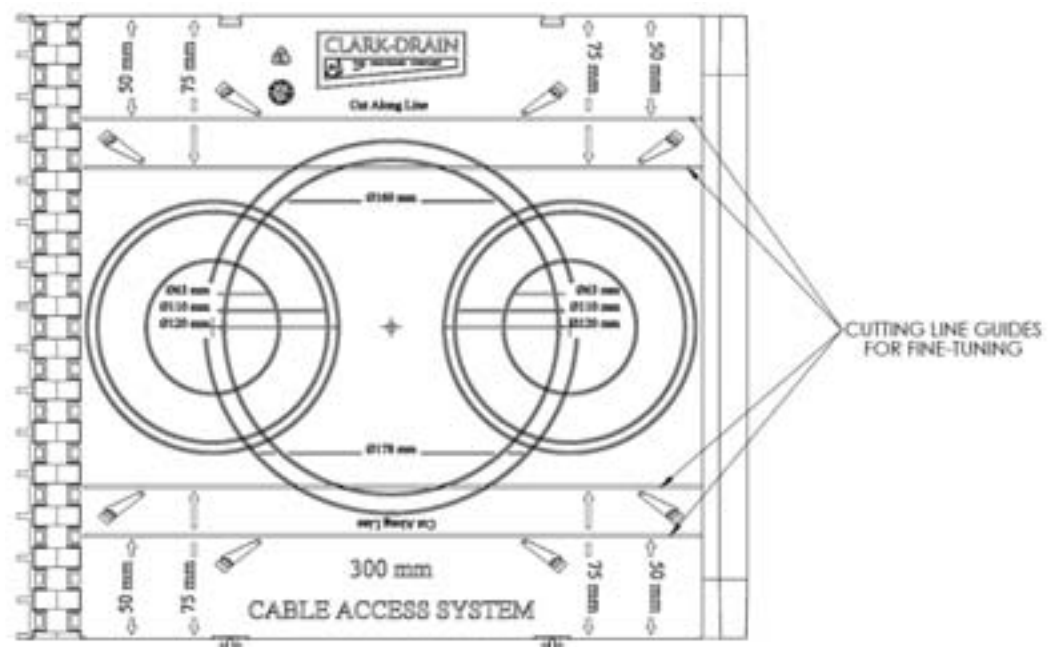

Installation:

1. Mark out the area where the pit is to be excavated, allowing a minimum of 125mm (or more to allow space to work as needed) around the full perimeter of the chamber for backfilling.
2. Within the marked area, excavate from finished surface level to the total depth of the chamber, plus the depth of the concrete base, plus the depth of the access cover and frame.
3. Once the pit has been excavated, compact the base then install position the anchor iron if required in its intended position before pouring a concrete base to form the foundation of the chamber. The concrete used for the base should be of at least C20 grade and be at least 100mm thick. While the concrete is still wet it is recommended that the bottom ring of the chamber be set into it by approx. 25mm
4. Assembly of the chamber panels to form full rings is simple and merely requires each male/female corner joint to be slid together as shown:



5. When the first ring is assembled and in position finish the base using a float and trowel to achieve an even surface.
6. The remaining sections of the chamber can then be installed on top of the base ring, in the sequence shown:

STEP 1

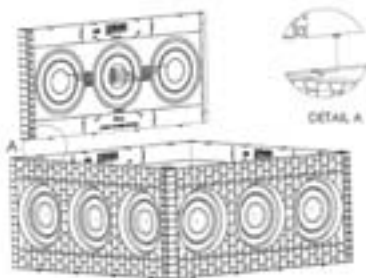

STEP 2

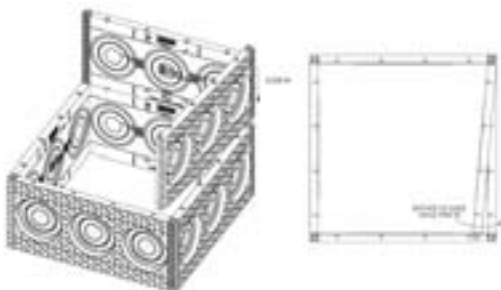

STEP 3

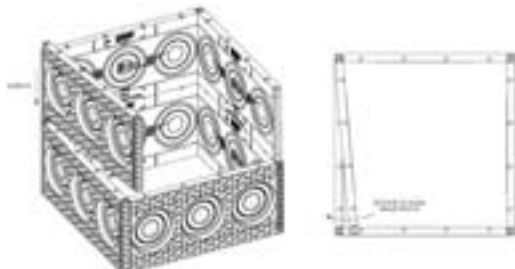

STEP 4

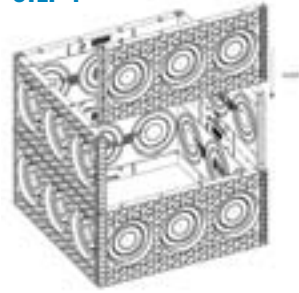

STEP 5

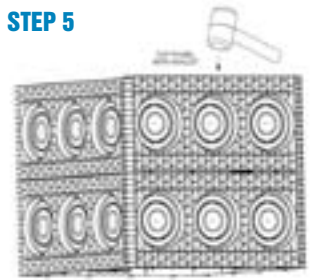

Repeat for each additional chamber layer:

7. Prior to back-filling around the chamber, the inside walls **must** be fully and substantially braced to avoid the walls bowing inwards during back-filling and compaction. This bracing should only be removed when the chamber installation is complete and all concrete used has fully cured.
8. For all applications the back-fill should be concrete of at least C20 grade. Back-fill in 300mm maximum layers and allow to cure before applying the next layer. Chambers installed in turfed or soft-standing areas should also have a concrete ring formed and set around the frame of the access cover of at least 75mm wide x 50mm deep to prevent damage to the access cover by non-road vehicles (e.g. lawn-mowers) and/or long-term sinking issues.
9. When the back-filling is complete and concrete has fully cured the access cover and frame can be fitted directly on top of the chamber, and attached/secured using the fixing holes provided on all 4 sides of the frame skirt.

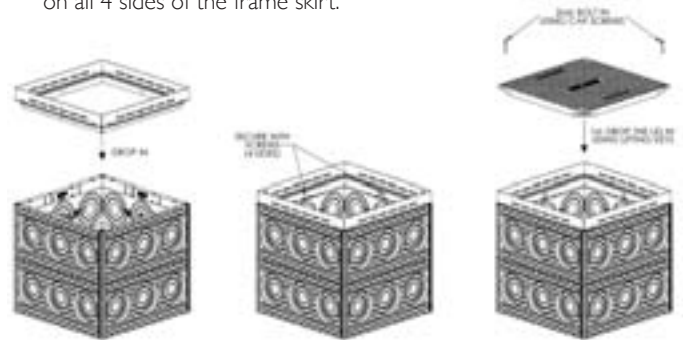

Example installation diagrams (600x600 C/O shown):

FOR SOFT STANDING AREAS

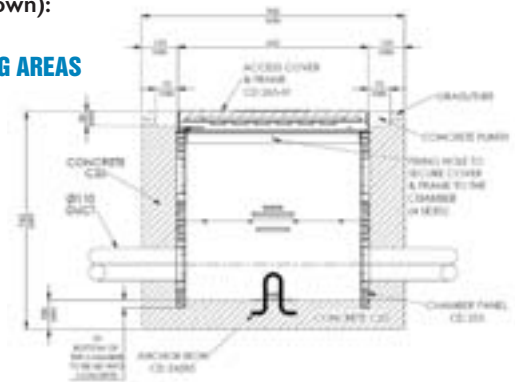

FOR HARD STANDING AREAS

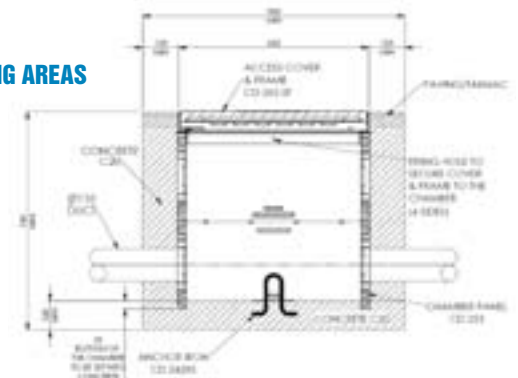

CLARK-DRAIN



THE DRAINAGE COMPANY

t: +44 (0)1733 765317
f: +44 (0)1733 246923
e: sales@clark-drain.com

www.clark-drain.com

STATION ROAD | YAXLEY | PETERBOROUGH | PE7 3EQ | UNITED KINGDOM

Due to our continual development programme, we reserve the right to upgrade products without prior notice.
All products must be installed in accordance with Clark-Drain installation guidelines.