



Product information

## **TORMAX 7501**

Multi-purpose combined sensor  
for maximum versatility and safety



## Contents

At a glance	3
Product features and benefits	4
Sensors and accessories	5
Applications	6
Detection field dimensions	8
Ceiling installation kit	9
Installation and configuration	9
Detection field for personal safety	10
Reduced energy loss in buildings	10
Minimizing unnecessary service calls	11
Technical data	12
Article overview	12

## At a glance

The TORMAX 7501 is an active infra-red sensor that combines door operation and personal safety features in a compact system. Thanks to its door-learn technology, the TORMAX 7501 offers enhanced safety and a wide range of possible applications. The TORMAX 7501 is an attractively priced, multi-purpose sensor for an extensive range of applications.

### Main benefits

- **Safe and EN16005/DIN18650/ANSI A156.10-compliant:** Three rows of infra-red safety light curtains for perfect protection in front of and between the door leaves, with integrated door-learn function
- **Versatile:** Independent setting for door operation and safety detection zones for all types of sliding, folding and swing doors
- **Reliable:** Automatic regulation and the precise specification of the monitoring area prevent unnecessary operation and, consequently, superfluous service calls
- **Efficient:** Direction detection technology for reducing hold-open times by up to 20% and for reducing energy loss in buildings by up to 10%.
- **Easy to use:** Plug and play installation

### Applications

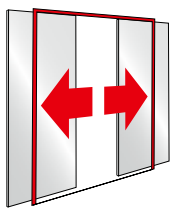

Linear sliding doors

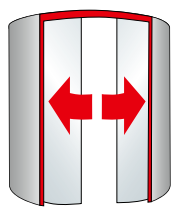

Curved sliding doors

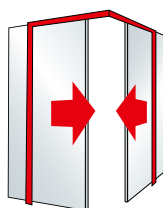

Angular sliding doors

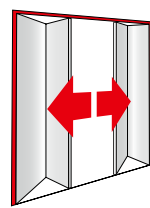

Folding doors

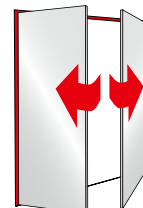

Swing doors

## Product features and benefits

- Configured and manufactured to comply with EN16005, combination of door-operation activators and safety systems in a single housing
- Installation and adjustment take only a few minutes. No light barriers required. This saves installation costs.
- Five-year warranty against manufacturing defects (competitors usually offer a three-year warranty for their products)
- Light curtain with three rows including door-learn function for the inner row with an inward direction of up to  $-8^{\circ}$  (comparable products have only two rows without a door-learn function)
- High level of safety against crushing or cutting edges
- High level of competitiveness thanks to ONE efficient, high-performance technology (active infra-red technology) for safety AND door-operation activators
- Greater precision in the adjustment of the detection range in comparison with radar detectors – this reduces the number of unnecessary door operations to a minimum
- Self-regulation in changing light and visibility conditions prevents unnecessary door operation



## Sensors and accessories

The TORMAX 7501 combined sensor includes a removable base in the scope of delivery. Depending on the required depth of the detection range, the sensor is mounted with or without the base.

For ceiling installation, appropriate accessories and fittings are available for installation and assembly. A weather hood is available for very exposed entrances to protect the appearance of the system from dripping water.

Sensors and accessories/fittings can be ordered separately (see last page for article numbers).



TORMAX 7501 combined sensor with base



Ceiling installation kit



Ceiling mounting kit



Weather hood

# Applications

The independent and precisely adjustable detection fields for door operation activation and personal safety cover a wide range of applications. The main applications are illustrated in the following:

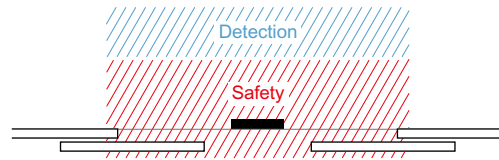

## Uninterrupted safety detection field for all sliding doors

The detection field can also be directed backwards. This way, the entire area between the door leaves is covered even for curved sliding doors.

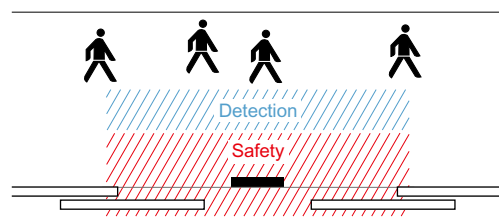
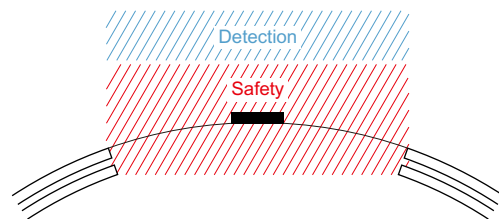

## Ideal for narrow passages or pavements

The width and depth of the detection field for door operation can be precisely adjusted. As a result, it is possible to prevent unnecessary door operation in narrow, busy locations.

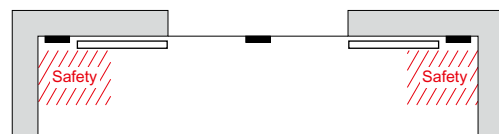

## Protection for secondary closing edges

The outer detection rows for door operation can be switched off. The sensor can thus be used specifically for the protection of the secondary closing edges.

**Accurate detection of people in the area of folding doors**

The width of the detection field of the three inner rows (safety) can be adjusted independently of the two outer rows (door operation) with a large adjustment range, and can thus be limited to the passage width of the folding doors.

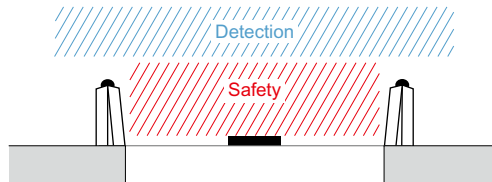

**Door operation activation and additionally ensuring low-energy operation of swing doors**

Ideal for attaining a high level of convenience for low-energy doors.

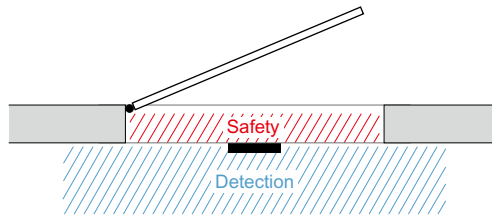

# Detection field dimensions

Layout

Cross-sectional view

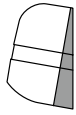

Detection fields with base

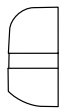
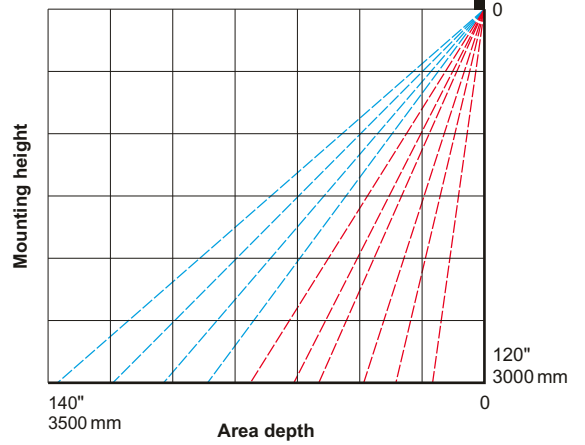
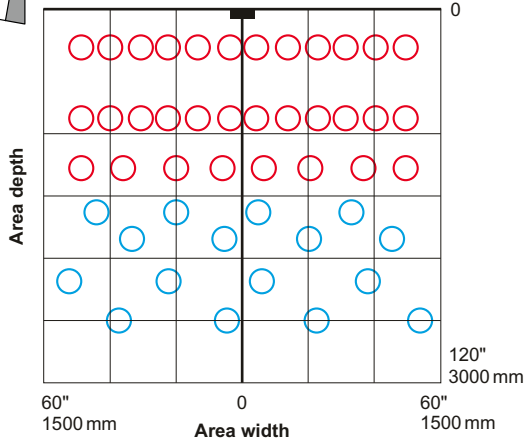

Detection fields without base

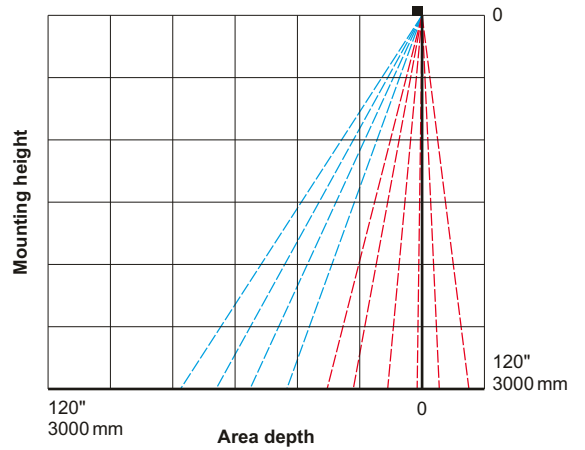
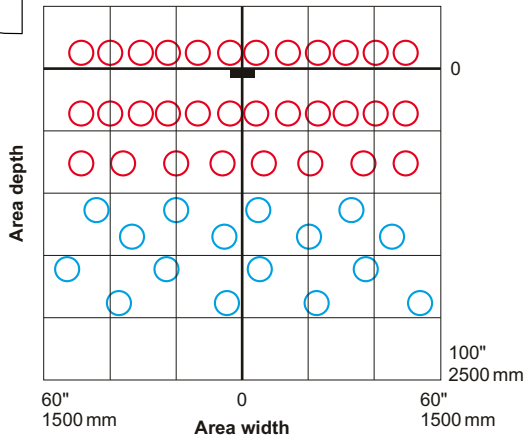



# Ceiling installation kit

The sensor can be fitted elegantly into the door frame with the aid of the ceiling installation kit.

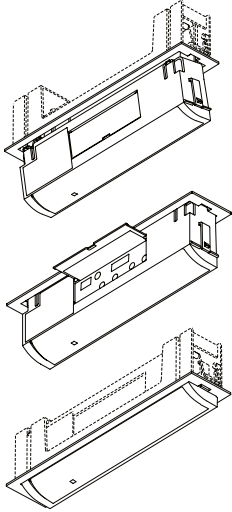

# Installation and configuration

Readymade harness, easy adjustment options for depth and width plus pre-configured DIP switches for standard applications ensure that the sensor is installed and ready for operation in a few minutes.

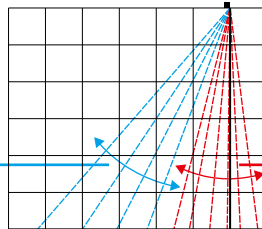

Depth adjustment for motion detection

Depth adjustment for presence detection



Harness with connector

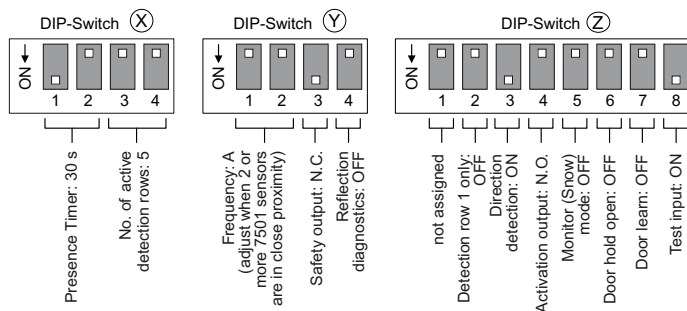

DIP switches pre-configured for TORMAX drives

## Detection field for personal safety

Most injuries related to automatic door systems are caused by ...

- people being hit,
- people falling when attempting to avoid the door, or
- people bumping into closed doors.

The TORMAX 7501 combined sensor has a safety light curtain with three rows of active infra-red sensor systems and a door-learn function for maximum personal safety.

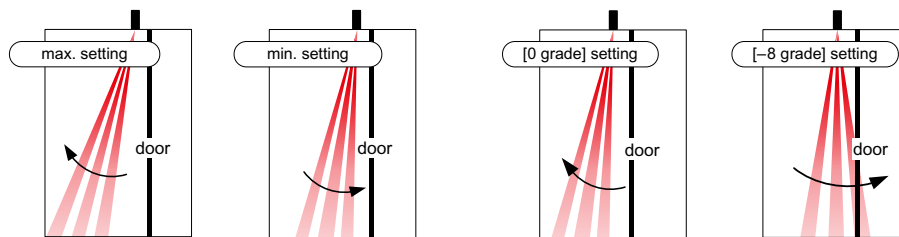

Three inner rows, with base

Three inner rows, without base

## Reduced energy loss in buildings

Thanks to its direction detection technology and high-accuracy detection range settings, the TORMAX 7501 can help reduce energy loss in buildings.

### Direction detection

The direction detection feature reduces door operation time as users who move away from the door do not keep the door open longer than necessary.

### Highly accurate width and depth settings for detection range

By switching on/off the active infra-red rows, the detection depth can be adjusted according to the ambient conditions. One to five rows can be activated. With the help of adjusting screws, it is possible to set the detection width individually for the outer “door operation” zone and the inner “personal safety” zone as well as separately for the left and right areas (see illustration).

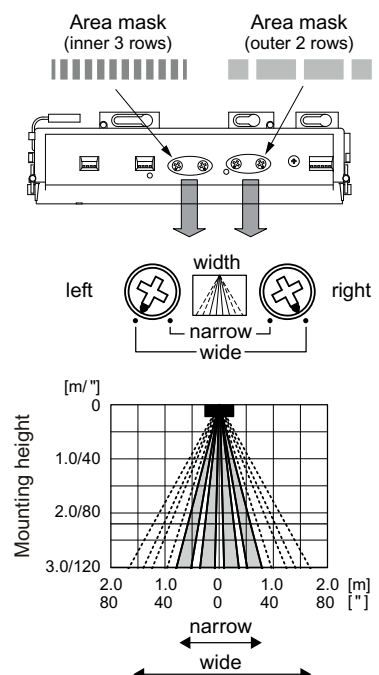

## Minimizing unnecessary service calls

The TORMAX 7501 combined sensor's automatic real-time regulating feature helps prevent unnecessary door operation caused by changes in environmental conditions such as bright sunlight, shadows, ground reflection, rain, snow or fog. Costly service calls required only for readjusting the sensor are no longer required. In contrast, there is a significant increase in customer satisfaction.

Automatic regulation under changing **light** conditions (sunlight, shadows, reflections)

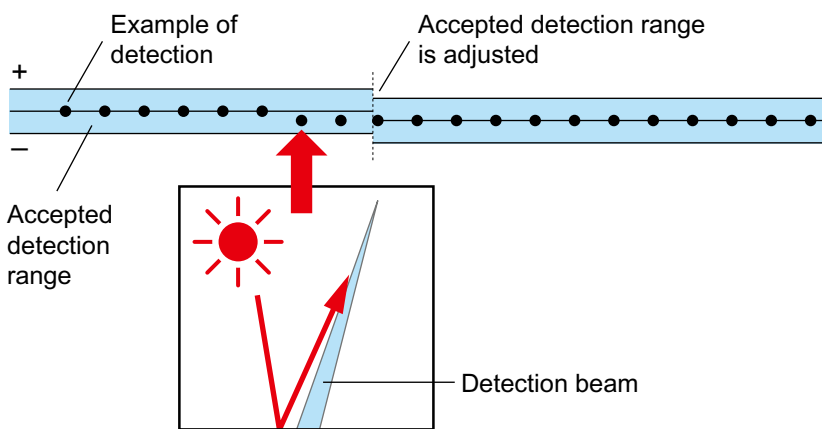

Automatic regulation under changing **visibility** conditions (rain, snow, fog)

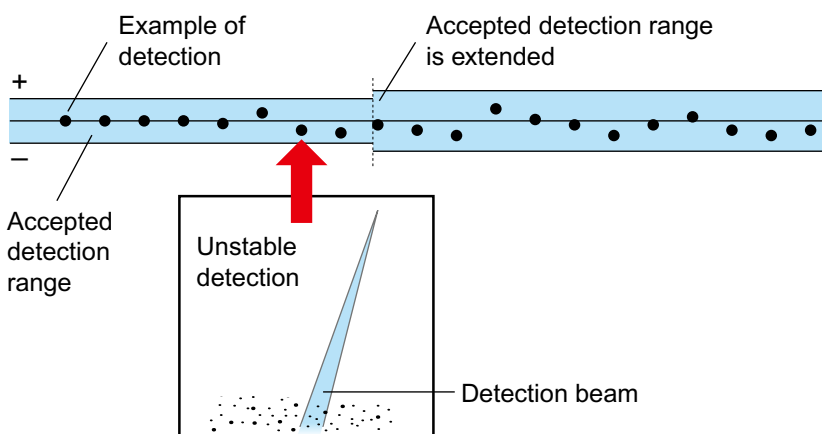

## Technical data

- Active infra-red technology
- LED display:
  - green (standby)
  - blue (motion detection 3.5 × 3 m)
  - red (monitored safety 3 × 1.5 m)
- Installation height: max. 3000 mm
- Dimensions (W×H×D): 230 × 70 × 44 mm
- IP rating 54 (splashproof)
- Operating temperature: -20°C to +60°C
- CE (TüV): EN 16005 (DIN 18650), ANSI A156.10

## Article overview

- TORMAX 7501 combined sensor  
(including 2.5 m harness with SINGLE PLUG connector) Article no. **501785**
- Harness 6 m with SINGLE PLUG connector Article no. **504903**
- Extension cable/harness 1 m Article no. **505784**
- Ceiling installation kit 7501 Article no. **502196**
- Ceiling mounting kit 7501 Article no. **502197**
- Protective weather cover 7501 Article no. **502198**