

**Product data sheet**  
**Dementia-Washbasin 950.11.106**

# HEWI

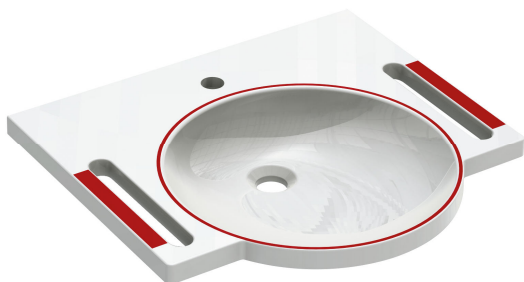

### Dementia-Washbasin 950.11.106

- with permanent red mark of the basin trough and the grab handles in HEWI colour 33 (ruby red)
- made of mineral composite with non-porous surface, alpine white
- with shelf and round basin
- integrated gripping feature on the side, can be used as a towel holder
- without overflow
- prepared for single hole mixer tap
- wheelchair accessible to DIN 18040 and ÖNORM B1600/1601
- weight capacity to EN 14688
- 600 mm wide and 550 mm deep
- for hanger bolt fixing
- CE marking according to Construction Products Regulation No. 305/2011
- System 800 K offers suitable sanitary accessories and barrier-free products in HEWI color 33 (ruby red)



### Dimensions in mm

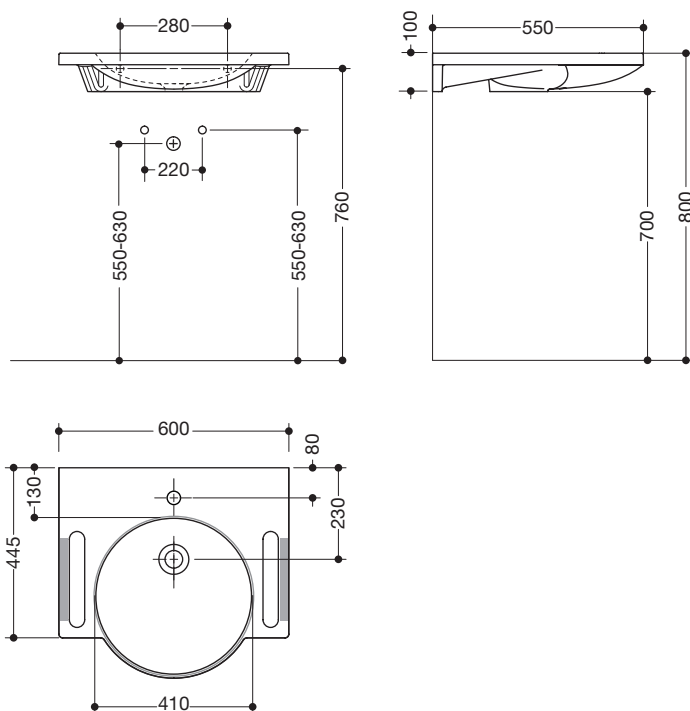

Technical information subject to alteration, 10th August 2020

HEWI Heinrich Wilke GmbH  
Postfach 1260  
D-34442 Bad Arolsen

Telefon: +49 5691 82-366  
Telefax: +49 5691 82-99366  
international@hewi.com  
www.hewi.com

HEWI (UK) Limited  
Holm Oak Barn, Beluncle Halt  
Stoke Road  
Hoo Kent ME3 9NT

Phone +44 1634 258 200  
Fax +44 1634 250 099  
info@hewi.co.uk  
www.hewi.com