



made for life

# UGINOX

A brand of Aperam

## Technical bulletin

Our high-grade stainless steels for roof  
and facade UGINOX® Patina - UGINOX® Top





St Barnabas Church, Edington - United Kingdom  
Brownhill Hayward Brown © Terence Smith Photography



Multipurpose facility, La Bresse - France  
SAS Cartignies Canonica © Aperam

## Introduction

- > The following information has been derived from the practical experience of product managers and professional users alike. Under no circumstances should this “technical bulletin” replace national standards and industry guidelines which must be observed at all times. Should you become aware that any information contained in this bulletin which contradict any national standards or guidelines that may be in force you must follow the more stringent recommendations ;
- > As an installer and/or a planner, you already possess the necessary technical expertise. You have an intimate understanding of the local conditions (wind exposure, snow loads, levels of rainfall, etc.) and use your expertise to plan and/or execute the necessary metal works. We therefore strongly advise you to take previously developed solutions into account and to make improvements where appropriate ;
- > Do not hesitate to get in touch with us if you have any questions about our information. At Aperam our skilled advisers are at your service to collaborate with you in developing tailored solutions for your projects. Through best practice in installing and processing our products, you too will win over satisfied customers in future.

All EN standards referred to in this bulletin should be read in conjunction with the EN standards of the relevant country.



Les terrasses de Corseaux, Vevey - Switzerland  
A&C Architecture+Consultant, Philippe Schumacher © A&C



Professional training centre, Dingolfing - Germany  
Schobner+Partner/Siegfried Horn © Aperam

# CONTENTS

## 1 Material specifications

---

### 1.1 Uginox Patina

- 1.1.1 Electrolytic tin plating
- 1.1.2 Patina formation
- 1.1.3 Material parameters
- 1.1.4 Applications of Uginox Patina
  - 1.1.4.1 Uginox Patina K41
  - 1.1.4.2 Uginox Patina K44

### 1.2 Uginox Top

- 1.2.1 Rolled matt surfaces
- 1.2.2 Material parameters
- 1.2.3 Applications of Uginox Top
  - 1.2.3.1 Uginox Top 304
  - 1.2.3.2 Uginox Top 316L

## 2 Corrosion resistance

---

- 2.1 Passive layer on stainless steel
- 2.2 Assembly with other metals
- 2.3 Formation and removal of extraneous rust
  - 2.3.1 Formation of extraneous rust
  - 2.3.2 Removal of extraneous rust
- 2.4 Resistance to bituminous construction materials
- 2.5 Resistance to vapour corrosion

## 3 Installation

---

- 3.1 Handling in low temperatures
- 3.2 Handling in humid conditions
- 3.3 Tools and machines
- 3.4 Decoiling
  - 3.4.1 Profiling
  - 3.4.2 Curved bending of prefabricated panels
    - 3.4.2.1 Convex curved bending of prefabricated panels
    - 3.4.2.2 Concave curve bending of prefabricated panels
  - 3.4.3 Installation of prefabricated panels
  - 3.4.4 Clips
  - 3.4.5 Snap-lock systems

### 3.5 Soldering

- 3.5.1 Soldering the joint
- 3.5.2 Soldering flux
- 3.5.3 Solder

### 3.6 Rivets

### 3.7 Angle grinders

### 3.8 Welding

### 3.9 Adhesives

## 4 Roof & wall cladding and edging

---

### 4.1 Roof pitches and cladding styles

### 4.2 Roof construction

- 4.2.1 Ventilated roofs ("cold roofs")
- 4.2.2 Unventilated roofs ("warm roofs")

### 4.3 Barrier layers

### 4.4 Lightning protection

### 4.5 Thermal expansion

### 4.6 Panel length and width

### 4.7 Gutter and pipe brackets

### 4.8 Soundproofing for stainless steel cladding

### 4.9 Energy sources

### 4.10 Verge and soffit detailing

### 4.11 Facades

## 5 Environmental impact

---

### 5.1 Seepage and discharge of water from precipitation

### 5.2 Use of water from precipitation

## 6 Product range

---

### 6.1 Uginox Patina and Uginox Top - metals in coil and sheet formats

- 6.1.1 Standard dimensions for Uginox Patina product
- 6.1.2 Standard dimensions for Uginox Top
- 6.1.3 Custom formats
- 6.1.4 Protective packaging

### 6.2 Accessories (guttering, gutter accessories and downpipes)

### 6.3 Identification of Uginox Patina and Uginox Top metals



# 1 Material specifications

## 1.1 Uginox Patina

### 1.1.1 Electrolytic tin plating

Uginox Patina K41 and Uginox Patina K44 stainless steel sheeting each feature electro-tinned coating (100% pure tin) on both sides. This thin metallic coating does not provide corrosion resistance; the plating in fact serves two purposes:

- > Formation of a homogenous, matt grey finish (known as patina);
- > Gives a surface which promotes easy application of soft solder in complex details.

### 1.1.2. Patina formation

Over time, weathering causes the electroplated tin to form a uniform, matt grey finish (a patina) on the exposed surface of the rust free stainless steel base material. Patina formation takes a correspondingly longer time on unweathered surfaces. During the handling process handprints and mild staining can occur that may cause temporary blotchiness to the surface, these disappear as the patination of the surface develops into an even, matt grey surface finish. Uginox Patina K41 and Uginox Patina K44 are supplied in an unweathered condition.

### 1.1.3 Material parameters

#### Description

These products comply with the requirements of EN 10088-4 and EN 502 for stainless steel sheeting and accordingly do not require any additional protective measures.

Manufacturer's product code	Uginox Patina K41	Uginox Patina K44
European product code	1.4509 * X2CrTiNb18	1.4521 * X2CrMoTi18-2
American product code	Type 441 **	Type 444 **

(\*) According to EN 10088-4  
 (\*\*) According to ASTM A240

#### Chemical composition (typical values)

Elements (%)	C	Si	Mn	Cr	Mo	Ti + Nb
K41	0.015	0.60	0.30	17.80	-	0.65
K44	0.015	0.50	0.30	17.70	1.85	0.45

#### Characteristics

	Mean values	K41	K44
<b>Physical characteristics</b>	Melting point °C	1505	1495
	Density	7.7	7.7
	Expansion coefficient mm/m at $\Delta T^\circ=100^\circ C$	1.1	1.08
	Thermal conductivity W/m.K at 20°C	25	23
<b>Mechanical characteristics (Transversal measurement)</b>	Yield strength 0.2 MPa	310	380
	Tensile strength Mpa	480	520
<b>Technical characteristics</b>	Standard thickness mm*	0.40	0.50
	Mass kg/m <sup>2</sup>		
	0.40 thickness	3.08	
	0.50 thickness	3.85	3.85
	Magnetic	Yes	Yes

<sup>(\*)</sup> Minimum material thicknesses for corresponding national standards and for each application or component must be observed.

### 1.1.4 Applications of Uginox Patina

#### 1.1.4.1 Uginox Patina K41

For more than 30 years, Uginox Patina K41 (grade 1.4509 to EN 10088-4) has proved itself as a market leader in roof cladding and roof drainage products in urban and rural environments alike. Uginox Patina K41, as a ferritic, magnetic stainless steel is particularly easy to cut and is highly malleable.

#### 1.1.4.2 Uginox Patina K44

Uginox Patina K44 has proved itself to be an exemplary standard in aggressive environments. Accordingly, Uginox Patina K44 is more suitable for applications in aggressive industrial atmospheres and also in near coastal regions. Uginox Patina K44 is highly resistant to exposure to humic acids and is ideally suited to all kinds of rooftop vegetation. When attacked by particularly aggressive materials, in rare cases discoloration and streaking may form on the surface; however, these do not lead to corrosion of the stainless steel material. Should it be necessary to avoid such aesthetic issues, the use of Uginox Top is recommended as discoloration and streaking from the byproducts of chemical reactions do not typically form on its rolled matt surface. As with all materials individual material combinations may increase overall corrosion damage. Ask your technical adviser for more information.

## 1.2 Uginox Top

### 1.2.1 Rolled matt surface

Uginox Top 304 and Uginox Top 316L feature rolled matt surface on both sides. The rounded edges within the surface microtexture reduce refraction providing benefits of a matt appearance. As the microtexture is unfocused (i.e. depressions in the surface are rounded) rotation of the material surface does not cause any disruptive reflections or differentiation in brightness.

This surface finish displays its final matt appearance and integrates perfectly in any rural or urban surrounding. It harmonizes with a wide range of architectural styles and with elements of both traditional and modern architecture.

### 1.2.2 Material parameters

#### Description

These products comply with the requirements of EN 10088-4 and EN 502 for stainless steel sheeting and accordingly do not require any additional protective measures.

Manufacturer's product code	Uginox Top 304	Uginox Top 316L
European product code	1.4301* X5CrNi18-10	1.4404* X2CrNiMo17-12-2
American product code	Type 304 **	Type 316L**

(\*) According to EN 10088-4

(\*\*) According to ASTM A240

#### Chemical composition (typical values)

Elements (%)	C	Si	Mn	Cr	Ni	Mo
304	0.05	0.40	1.10	18.20	8.05	-
316L	0.025	0.40	1.20	16.80	10.10	2.10

#### Characteristics

	Mean values	304	316L
<b>Physical characteristics</b>	Melting point °C	1450	1440
	Density	7.90	7.90
	Expansion coefficient mm/m at $\Delta T=100^{\circ}\text{C}$	1.60	1.60
	Thermal conductivity W/m.K at 20°C	15	15
<b>Mechanical characteristics (Transversal measurement)</b>	Yield strength 0.2 MPa	300	300
	Tensile strength Mpa	650	620
<b>Technical characteristics</b>	Standard thickness mm*	0.40 0.50	0.50
	Mass kg/m <sup>2</sup>		
	0.40 thickness	3.16	
	0.50 thickness	3.95	3.95
	Magnetic	No	No

\*Minimum material thicknesses for corresponding national standards for each application or component must be observed.

### 1.2.3 Applications of Uginox Top

#### 1.2.3.1 Uginox Top 304

Uginox Top 304 (material number 1.4301 to EN 10088-4) gives excellent performance in applications including roof covering, roof drainage and facades applications in urban and rural environments with normal environmental conditions.

#### 1.2.3.2 Uginox Top 316L

Uginox Top 316L (material number 1.4404 to EN 10088-4) gives class-leading resistance in particularly aggressive environmental conditions in use as roof coverings, roof drainage and façade systems.

As a material with a strong resistance to corrosion it makes it particularly suited for applications in aggressive industrial atmospheres and in near coastal regions. This also applies in environments featuring particular exposure to chlorides such as swimming pool installations and where deicing salt and saltwater vapour is present for example on high-traffic roads and bridges (due to traffic creating a mix of melt water and road salt). Uginox Top 316L features enhanced resistance to ammonia (e.g., for use in agriculture through animal rearing and fruit storage in the food and dairy industries and in water treatment plants). Uginox Top 316L is suitable for roofs featuring vegetation where metal may be attacked by humic acids and in assembly with highly alkaline materials such as concrete, chalk and cement mortar and unwashed gravel or sand. When Uginox Top is used, discoloration and streaking from the by products of chemical reactions do not typically form on its rolled matt surface.

Product suitable for	Roof	Drainage	Particular chemical exposure*	Facades, flashings & soffits	Aesthetic requirements*	Edge capping (roof)	Fascia boards & cover
Uginox Patina K41	Yes	Yes	No	No	Yes	Yes	Yes
Uginox Patina K44	Yes	Yes	Yes	No	Yes	Yes	Yes
Uginox Top 304	Yes	Yes	No	Yes**	Yes	Yes	Yes
Uginox Top 316L	Yes	Yes	Yes	Yes	Yes	Yes	Yes

(\*) See information for the relevant product

(\*\*) See information for skirting

## 2 Corrosion resistance

### 2.1 Passive layer on stainless steel

Stainless steel is a collective description for a variety of different kinds of steel which are alloyed with at least 10.5% Chromium and which contain less than 1.2% Carbon. During oxidation, a stable oxide layer (the passive layer) forms spontaneously. This passive layer protects the underlying metal from corrosion.

### 2.2 Assembly with other metals

Uginox Patina and Uginox Top behave neutrally in respect of other metals. No electrolytic stress corrosion or pitting occurs when assembled in combination with other metals. The sole exception is unprotected carbon steel ("normal steel"), which causes extraneous rust on Uginox Patina and Uginox Top which then leads to corrosion (see 2.3.1). Uginox Patina and Uginox Top can be combined directly alongside other metals in construction (excluding unprotected carbon steel), albeit that variation in expansion behavior in each of the combined metals will be observed.

Neither direct precipitation nor water run-off dripping from other metals onto Uginox Patina or Uginox Top (excluding from unprotected carbon steel) can cause corrosion damage (see 2.3.1.).

### 2.3 Formation and removal of extraneous rust

#### 2.3.1 Formation of extraneous rust

Extraneous rust is made up of strongly adhesive carbon steel ("normal steel") particles that have attached themselves to Uginox Patina and Uginox Top and are then transformed into the corrosion by-product ("rust") via chemical reactions. Longer term adhesion of extraneous rust causes pitting in all metals, including stainless steel.

- > Attaching the separation layer under the roof cladding with nails or clips that are not protected against corrosion ;
- > Rusting items or debris being left on the metal during installation and site operations ;
- > Flying sparks and grinding dust from angle grinding ;
- > Welding beads from metalworking ;
- > Rusty water dripping from other components ;
- > Abrasion from carbon steel tools (tool steel) during work on metal components.

#### 2.3.2 Removal of extraneous rust

If early-stage corrosion is discovered on stainless steel the destructive material (extraneous rust) and the passive layer of the stainless steel must be removed in full. This typically takes place through cleaning with 20% nitric acid or 50% phosphoric acid, followed by thorough rinsing with water. Under the environment of the surrounding atmosphere the passive layer regenerates independently.

### 2.4 Resistance to bituminous construction materials

Uginox Patina and Uginox Top do not suffer any impediment from the products of the decomposition of substances containing bitumen (no bitumen corrosion).

Uginox Patina and Uginox Top offer ideal conditions for joining both bituminous and polymer bitumen membranes.

Scientific and technical investigations from independent institutions confirm the adhesive strength of a bituminous seal on Uginox Patina via the tear growth test (DIN 53356).

Values of 136 and 185N/5cm were recorded, at which a break in cohesion in the underlying coating occurred, meaning that the adhesion of the membrane to the tin-plated stainless steel is stronger than the bituminous membrane's internal cohesion. Primer is not required for use with bituminous membranes. If self-adhesive bitumen membranes are to be used the relevant manufacturer's guidelines must be followed.

### 2.5 Resistance to vapour corrosion

Uginox Patina and Uginox Top resist vapour or hot-water corrosion, i.e., corrosion from water vapour ("condensation") forming on the underside of the metal cladding. Particular measures to protect against vapour and hot water corrosion, such as drainage layers ("underslating") are therefore unnecessary.

## 3 Installation

Uginox Patina and Uginox Top were specifically developed for roofing, roof drainage, facade coverings and edging applications and therefore adapted to meet the needs of architects and metalworkers.

With correct handling and installation Uginox Patina and Uginox Top stainless steels will last for several generations before evaluation for replacement.

Warn all construction trades, in particular carpenters, steel and metal workers, sanitation and ventilation engineers, about the consequences of extraneous rust build up on metal surfaces (see 2.3.1), to ensure that they use appropriate fasteners. The stainless steel surfaces must be protected during all grinding, drilling and welding operations. Ideally such grinding, drilling or welding operations should be undertaken in a separate area.

### 3.1 Handling in low temperatures

Uginox Patina and Uginox Top can be worked at low temperatures (even below freezing) without the need for any particular precautions and without any risk of brittle fractures or hairline cracks. There is no requirement to pre-warm Uginox Patina or Uginox Top when working at low temperature.

### 3.2 Handling in humid conditions

Uginox Patina and Uginox Top are impervious to moisture such as rain or snow and can be worked on in humid conditions without any specific consideration.

### 3.3 Tools and machines

Uginox Patina and Uginox Top can be worked on using standard metalworking tools and machines. Attention should be given to ensuring that the tools and machines are free of rust and other extraneous metallic particles. The workbench should be swept clean before starting work. Stainless steel tools will not leave behind any rust-causing shavings on Uginox Patina or Uginox Top (see 2.3.1). Profiling and folding machines must be specifically configured for working Uginox Patina and Uginox Top, in which case the machine manufacturer's instructions must be followed. ((Schlebach, Draeco and other suppliers will supply their own instructions for working with Uginox Patina and Uginox Top upon request).

### 3.4 Decoiling

As stainless steels spring back more than copper, zinc or aluminum, particular care must be taken when decoiling. The material must be decoiled under pressure so that any residual stresses in the metal panels are suppressed during decoiling (see diagram).

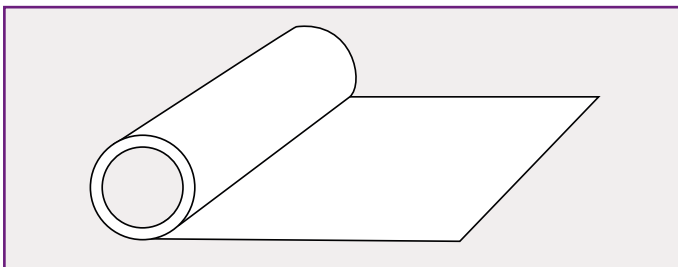

Decoil applying pressure from underneath.

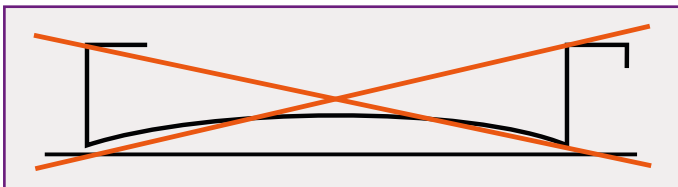

Decoil any buckling arising from pressure from above with pressure from underneath.



Neutralise buckling by decoiling under pressure from below.

#### 3.4.1. Profiling

Like all stainless steels, Uginox Patina and Uginox Top have a greater mechanical strength than copper, zinc or aluminum and are therefore able to be worked at lower thicknesses than other materials. For this reason, profiling machines must be specially configured (see manufacturer's specifications).

The machines can be set up according to the machine manufacturer's specifications and within a brief period of time. (Schlebach, Draeco and other manufacturers will supply their own instructions for working with Uginox Patina and Uginox Top on request).

The installation angles given in the diagram below must be observed in respect of prefabricated panels with double lock standing seams using Uginox Patina and Uginox Top. The correct installation angles must be set for the prefabricated panel.

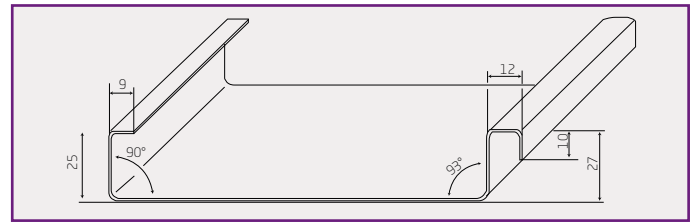

Applying a smaller installation angle causes excessive bulging of the panels when cutting the seam. The incorrect profiling of the metal can induce excessive bulging of the panel which is undesirable and can initiate wind noise (see 4.8).

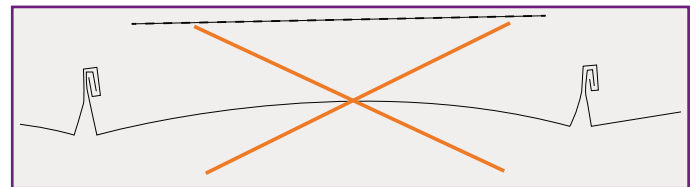

The excessive bulging of panels can also occur when the installation angle is too flat.

#### 3.4.2 Curved bending of prefabricated panels

Curved or arch bending of prefabricated panels using Uginox Patina and Uginox Top requires the machine to be set to the manufacturer's specifications for working with stainless steel (Schlebach and other manufacturers will provide specific technical information on request).

##### 3.4.2.1 Convex curved bending of prefabricated panels

Convex curved bending of prefabricated panels using Uginox Patina and Uginox Top is possible down to a radii of 1.50 m without any issues. Smaller bending radii than 1.50 m are possible using specific machine settings but should be checked for suitability after testing sample panels. When curving to a small radius it is especially important to process the metal through a series of gradual reductions until the desired radius is achieved. The required form of the incoming panel end can then be finished after the curving process is completed.

##### 3.4.2.2 Concave curve bending of prefabricated panels

Concave curve bending of prefabricated panels using Uginox Patina and Uginox Top is only possible to a limited extent as stainless steel presents considerable resistance to compression. Concave curve bending is a specific functionality that requires additional components to be added to the curve bending process and equipment. The suitability of the resulting panels must always be checked after testing sample panels.

#### 3.4.3 Installation of prefabricated panels

Typically, the seams of prefabricated panels using Uginox Patina and Uginox Top are crimped by machine. Alternatively, the seams can also be crimped by hand, which results in particularly low stresses during the installation.

### 3.4.4 Clips

Only stainless steel clips with rounded edges may be used. Clips should be fastened using annular ring shanked stainless steel nails (2.8 × 25 mm) or stainless steel countersunk screws (4 × 25 mm).

- > Install the profiled panel with the overcloak edge fitted over the previous panel. As such, the panels cannot be separated from one another. If necessary, panels can be held together using clamps ;
- > Before mechanically crimping the seam must be crimped by hand for approximately the first metre, this allows the correct attachment of the mechanical seam folder ;

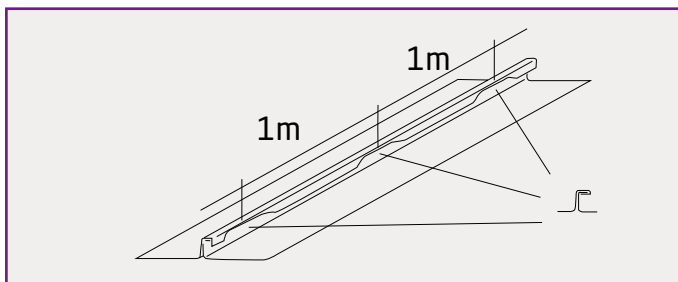

- > Precast crimp necks for use with a folding machine ;

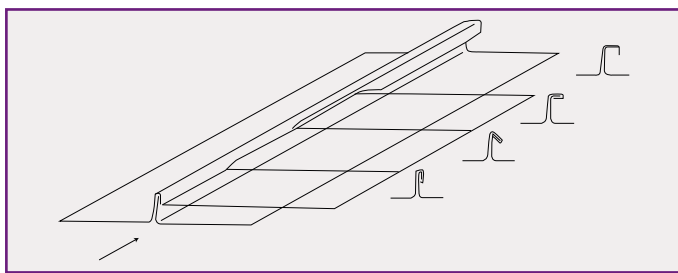

- > Apply the clips to the underside of the cladding. Accordingly, the panel may not be moved and the clips cannot be turned or fastened off-centre. Attaching the clips correctly to the undercloak aligns the panel and avoids the clips being twisted or fastened off-centre ;

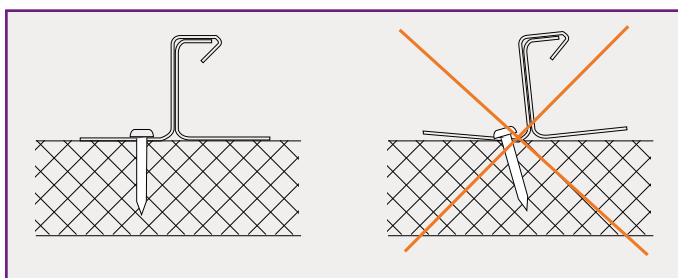

- > Folding the leading edge of the clips ;

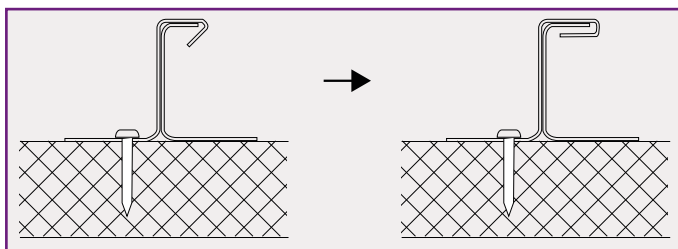

### 3.4.5 Snap-lock systems

The high mechanical strength and rigidity make Uginox Patina & Uginox Top particularly suitable for the Snaplock® system. The system is designed to reduce site installation time, thereby delivering economy, but not compromising on quality.

The pre-profiled sheets are simple to engage and deliver

benefits of reduced visual wave formation, i.e , improved flatness and appearance. Snaplock® fabrication is an off-site procedure reducing site activity and thereby improving safety.

The building height and tray widths should be respected and be in accordance with the profile height and the roof slope. Snaplock® is available in 25 mm or 38 mm standing seam profile heights, in lengths up to 12 linear metres.

Longer length panels are possible with access for on site rolling.

In all cases, national standards and guidelines relating to installation must be observed.

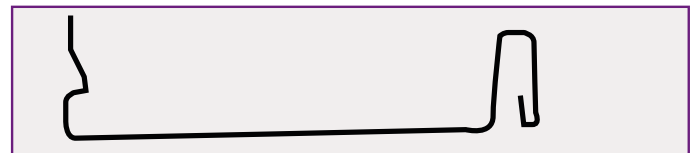

Snap lock 25 mm flattened (in Austria 25.40 mm)

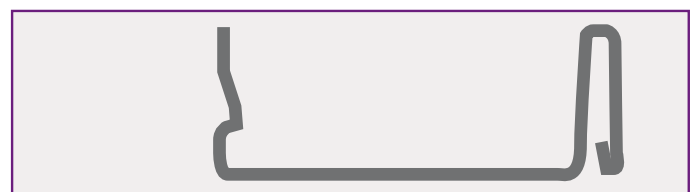

Snap lock 38 mm flattened

## 3.5 Soldering

### 3.5.1 Soldering the joint

Joints can be soldered in certain circumstances with overlaps of 10-15 mm. Uginox Patina allows rivets to be dispensed with as a sound soldered joint with a width of 15 mm is sufficient to transmit all normally occurring forces. Rivets are however recommended for force transmission with Uginox Top. Tin plated stainless steel rivets will significantly simplify over soldering.

Larger overlaps than the recommended 10-15 mm typically do not allow for a sound joint to be soldered and create a risk of flux residue contamination in the overlap. On longer exposure to water flux, residue may leak from the overlap and cause discoloration or streaking on the surface. Overlaps greater than 15 mm in size are therefore not recommended.

As Uginox Patina and Uginox Top have low thermal conductivity it is necessary to employ a low soldering temperature and, if appropriate, to work on one section at a time in order to avoid overheating the solder or delaying the solidification of the solder during cooling. After the solder joint has been completed, all flux residues should be removed with copious amounts of clean water and dried with a clean cloth. Flux residues can lead to surface discoloration and aesthetic issues.

### 3.5.2 Soldering flux

Soldering flux based on orthophosphoric acid is recommended for Uginox Patina and Uginox Top. The flux must not contain chloride ions. A custom flux, "Ferrinox" is available for Uginox Patina and Uginox Top, which can be easily obtained from the metal supplier. Warning: Chloride based soldering flux is not suitable for Uginox Patina and Uginox Top.



### 3.5.3 Solder

Solders for use with Uginox Patina and Uginox Top are tin based alloys with a tin content of at least 33% (e.g., S-Pb 70 Sn 30). Soldering tin must not contain more than 0.5% antimony.

## 3.6 Rivets

For aesthetic reasons stainless steel rivets are recommended. Tin-plated stainless steel rivets are available and will significantly simplify over-soldering. All rivets used must have a stainless steel shaft. Copper rivets should not be used.

## 3.7 Angle grinders

The use of an angle grinder to cut Uginox Patina and Uginox Top is not recommended. The cut edges can overheat thereby reducing the resistance to corrosion. Formation of extraneous rust - see 2.3.1.

## 3.8 Welding

Uginox Top is generally suitable for all welding activities. Uginox Top 316L (material number 1.4404 to EN 10088-4) is recommended for roll-seam welding.

Welding of Uginox Patina is not recommended due to the combustible tin layer.

## 3.9 Adhesives

Experience to date shows that Uginox Patina and Uginox Top are suitable for the application of adhesives.

The guidelines of the relevant adhesive manufacturers must be followed in respect of specific adhesion and handling techniques.

## 4 Roof & wall cladding and edging

All roof and facade construction as well as classical metalwork edging can be carried out with Uginox Patina and Uginox Top using traditional techniques. The particularly high strength and corrosion resistance of Uginox Patina and Uginox Top open up new possibilities in design and construction techniques. As such, Uginox Patina and Uginox Top are particularly well suited for limitless uses in modern architecture, in the renovation of existing buildings and for the conservation of historic buildings.

### 4.1 Roof pitches and cladding styles

Substructures for metal roofs should be planned and executed with a roof pitch of  $>7^\circ$  wherever possible.

All roof styles with the appropriate pitch can be created using Uginox Patina and Uginox Top. With the minimum pitches provided, the permissible deflection of the substructure must also be taken into consideration. The corresponding, country-specific standards and regulations for longitudinal and lateral joints must be considered and the more stringent provisions must be followed.

Kinds of cladding	Recommended minimum pitch
Seam welded stainless steel cladding using Uginox Top $\geq 0^\circ$	$\geq 0^\circ$ / Water accumulation resistance
Double lock standing seam cladding with extra measures*	$\geq 3^\circ - 7^\circ$
Double lock standing seam	$\geq 7^\circ$
German batten cap cladding	$\geq 10^\circ$
Angle standing seam cladding**	$\geq 25^\circ$
Belgian batten cap cladding	$\geq 25^\circ$ and $\leq 80^\circ$

\* With roof pitches  $\geq 3^\circ$  to  $10^\circ$  extra features such as sealing tape inserts, seam resins or watertight or water repellent bituminous membrane are required.

\*\*  $\geq 35^\circ$  for enhanced requirements. Enhanced requirements could arise due to climatic conditions or other exposed locations, e.g., strong wind or heavy snowfall.

Double lock standing seams do not constitute a rain resistant cladding. This can be achieved through additional measures such as seam resin.

### Eaves flashing plate

The eaves flashing plate requires a cover and the fascia cover must remain partially exposed. These measures are required to avoid a capillary effect developing in the eaves.

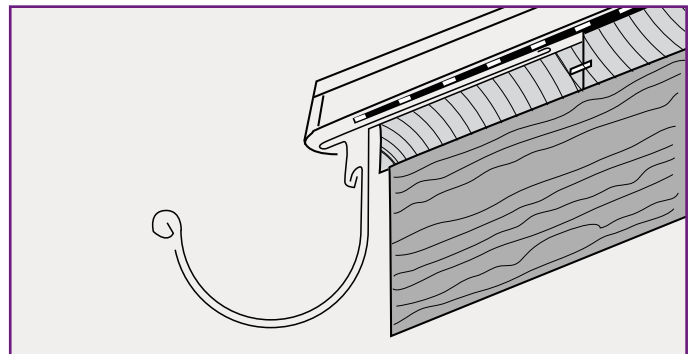

Construction from top to bottom:

- > Uginox Patina/Uginox Top double lock standing seam ;
- > Water-diffusing membrane (a roof pitch  $<10^\circ$  requires a water-repellent membrane or other seam sealing measures);
- > Exposed fascia cover ;
- > Reverse angled hangers ;
- > Plywood  $\geq 24\text{mm}$ , sunken fascia board ;
- > Load bearing structure.

## 4.2 Roof construction

Uginox Patina and Uginox Top allow ventilated ("cold roof") and non-ventilated ("warm roof") roof construction to be completed without issues. There is no risk of so-called "vapour corrosion" (see 2.5).

### 4.2.1 Ventilated roofs ("cold roofs")

Ventilation should be specified and carried out following the country-specific standards. It is recommended to provide a water repellent (but not fully impermeable separation) layer underneath the Uginox Patina or Uginox Top sheet covering.

### 4.2.2 Unventilated roofs ("warm roofs")

The construction project must be specified and carried out according to the observed good practice and the country specific standards. Accordingly a suitable vapour barrier or vapour control layer must be provided.

### 4.3 Barrier layers

---

It is recommended to provide a water repellent (but not fully impermeable barrier) layer underneath the Uginox Patina or Uginox Top cladding. A barrier layer with a drainage function is only required when wood paneling is used as the supporting base for the construction. During installation of a barrier layer, ensure that it is not too thick and that it does not cause any bunching that could become visible in the sheet metal. Non-rusting materials must be used to secure the barrier layer (see Extraneous rust, 2.3.1).

### 4.4 Lightning protection

---

Uginox Patina and Uginox Top are electrically conductive materials and can be incorporated in a lightning protection system. Roofing using stainless steel panels creates the effect of a lightning conductor. If the roof is incorporated in a lightning protection system these parts must fulfill the appropriate country-specific standards for lightning protection.

### 4.5 Thermal expansion

---

The low thermal expansion of Uginox Patina and Uginox Top allows long panels and roof sheets. The expansion of the panels in both length and breadth must be taken into consideration and a detailed plan should be prepared. Expansion coefficients for Uginox Patina are provided at 1.1.3 and for Uginox Top at 1.2.2.

### 4.6 Panel length and width

---

Uginox Patina and Uginox Top allow large panel sizes subject to appropriate construction methods and detailed planning based on consultation with the manufacturer\*. In general, panels for roofs and facades using Uginox Patina and Uginox Top should only be used with material in minimum thickness of 0.5 mm.

\*Permitted panel width is determined by the national standards and/or guidelines and/or the wind load calculation.

### 4.7 Gutter and pipe brackets

---

Gutters using Uginox Patina and Uginox Top should be secured with gutter brackets made from stainless steel (material number 1.4301 to EN 10088-4), or zinc-plated steel with or without a coating of Uginox Patina or Uginox Top.

Rainwater downpipes made with Uginox Patina or Uginox Top should be secured with pipe brackets made from stainless steel (material number 1.4301 to EN 10088-4) or zinc-plated steel pipe brackets.

### 4.8 Soundproofing for stainless steel cladding

---

All metal cladding roof sheets are challenged by various sources of sound that combine to form an overall noise level that affects the entire roof construction. In general, lightweight beam structures made of wood and steel are more susceptible to noise disruption than heavy concrete structures.

Soundproofing of roof cladding using Uginox Patina or Uginox Top must always be carried out in the context of the entire roof construction project and its various requirements.

**Soundproofing against wind and rain noise.**

Wind noise occurs when metal cladding lies in the slipstream of the wind. The individual panels of the roof can be lifted by the slipstream to form a cushion and upon the change of direction of the laminar airflow are set in motion by the alternating vortex. This gives rise to unpredictable noises from the metallic panels which are then transmitted via the roof construction.

Susceptibility to noise increases as the roof pitch decreases, particularly in the corners and at the edges of the roof, where the slipstream is pronounced.

Reductions in noise emissions can be achieved through narrower panels at all exposed edges of the roof area and/or through the installation of a soft acoustic separation layer.

Alternatively, a high degree of noise absorption can be achieved via a noise-damping layer with low rigidity and high specific mass.

### 4.9 Energy sources

---

The attachment of solar or photovoltaic cells represents a particular challenge for double lock standing seam metal roofs.

Sufficient options to attach energy sources should be considered and be designed for at the planning stage.

Clamp attachments on seams are permitted if official approval is given and provided that the panels are sufficiently secured. All changes in physical load and thermal performance of the roof sheets must be calculated. For existing metal roofs, it is necessary to check the suitability of the existing metal cladding including such attachments. Thin layer modules can be attached directly to Uginox Patina and Uginox Top in accordance with manufacturer's instructions.

For existing metal roofs, it is necessary to check the suitability of the existing metal cladding including an inspection of the panel fixings and attachments.

### 4.10 Verge and soffit detailing

---

For aesthetic reasons it is recommended to use Uginox Top 304/316L (material number 1.4301/1.4404) for roof verge and soffits. Uginox Top 316L does not undergo any surface changes under natural external influences. The use of Uginox Top 304 is only suitable in exceptional circumstances and this should be discussed with Aperam. The use of Uginox Patina should be avoided for aesthetic reasons as the limited natural precipitation of these areas will delay the desired patination process.

### 4.11 Facades

---

For areas such as facades and undersides, etc. which must satisfy high aesthetic expectations, we recommend our Uginox Top product range. In particular, it should be noted that only material from a single parent coil is provided in any order.

## 5 Environmental impact

Long-term studies have established that surfaces clad with Uginox Patina and Uginox Top do not show any measurable metal run-off. The run-off rates of Uginox Patina/zinc-plated chromium steel and Uginox Top/chromium-nickel-steel are below the measurement threshold of 0.01 micrometers per year [ $\mu\text{m/a}$ ].

Harm to the environment and in particular damage to microorganisms in soil ecosystems and on biological purification stages in water treatment works are not classified by public authorities as an established threat. Accordingly, the unrestricted use of Uginox Patina and Uginox Top in highly sensitive zones such as protected drinking water catchment areas and open water courses is possible.

### 5.1 Seepage and discharge of water from precipitation

As Uginox Patina and Uginox Top do not cause any measurable metal run-off they may be used without restriction in the seepage and discharge of water into water courses or waste water disposal systems.

Country-specific regulations can be found on our website [www.uginox.com](http://www.uginox.com).

### 5.2 Use of water from precipitation

As Uginox Patina and Uginox Top do not cause any measurable metal run-off they may be used without restriction for gardening or as "grey water" for washing machines and toilet flushing. As no measurable quantities of metallic ions are dissolved, no negative impact on water treatment facilities, mains networks or household appliances is anticipated.

## 6 Product range

### 6.1 Uginox Patina and Uginox Top - metals in coil and sheet formats

#### 6.1.1 Standard dimensions for Uginox Patina

Product	Format (mm)	Uginox Patina K41	Uginox Patina K44
		Thicknesses (mm)	Thicknesses (mm)
Sheets	1 000 x 2 000	0.40/0.50	on request
	250	0.40/0.50	on request
	330/333	0.40/0.50	on request
	500	0.40/0.50	0.50
Coils	580	0.40/0.50	0.50
	670	0.40/0.50	on request
	800	0.40/0.50	on request
	1 000	0.40/0.50	0.50
	1 160	0.40/0.50	0.50

#### 6.1.2 Standard dimensions for Uginox Top

Product	Format (mm)	Uginox Top 304	Uginox Top 316L	
		Thicknesses (mm)	Thicknesses (mm)	
Sheets	1 000 x 2 000	0.40/0.50	0.50	
	250	0.40/0.50	on request	
	330/333	0.40/0.50	on request	
	500	0.40/0.50	0.50	
	580	0.40/0.50	on request	
	Coils	625	0.40/0.50	0.50
		670	0.40/0.50	on request
		800	0.40/0.50	on request
		1 000	0.40/0.50	0.50
1 250		0.40/0.50	0.50	

Uginox Top is also available in metal thicknesses of 0.6, 0.8, 1, 1.2, 1.5 mm upon request.

#### 6.1.3 Custom formats

Uginox Patina and Uginox Top are available in multiple standard dimensions; and custom formats are possible upon request.

#### 6.1.4 Protective packaging

We do not recommend a coating on Uginox Patina.

Uginox Top 304 and Uginox Top 316L can be supplied with protective surface coatings.

The protective surface coatings are temporary and should be removed immediately after handling. Due to sun damage (UV light) aged coatings can become brittle whereby removal in large areas at a time prove difficult.

## 6.2 Accessories (guttering, gutter accessories and downpipes)

Guttering, gutter accessories and downpipes are available in Uginox Patina and Uginox Top in the current sizes.

Longer delivery times should be factored in non standard components.

## 6.3 Identification of Uginox Patina and Uginox Top metals

To prevent abuse and to enable identification, all sheets and coils are marked. The marking contains the product name, (e.g. Uginox Patina K41/K44, Uginox Top 304 and Uginox Top 316L), the thickness and the strip width (e.g., 0.5 x 580 mm) and an additional production coding.

Construction products manufactured in all Aperam plants and service centres comply with the CE standard.





© 2016, Aperam Stainless Europe. While every care has been taken to ensure that the information contained in this publication is as accurate as possible, Aperam Stainless Europe, in common with all Aperam Group companies, cannot guarantee that it is complete or that it is free from error. UGINOX® is a brand of Aperam - Stainless Europe, registered in numerous countries.

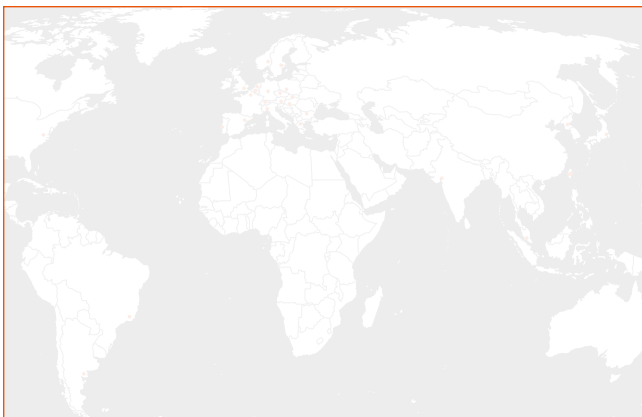

## Contact

[uginox@aperam.com](mailto:uginox@aperam.com)  
[www.uginox.com](http://www.uginox.com)



Printed on mixed FSC® certified/recycled paper using vegetable based inks  
[www.arthemis.co](http://www.arthemis.co)