

Catalogue 2017/18

Products for Children

HEWI

Tumbler Racks
Washbasins
Mirrors







Child-orientated Sanitary Rooms

Colourful Design

Sanitary rooms for children must be designed to be practical, easy care and safe. HEWI products for children are matched to the needs of their small users, whether in child daycare centres, kindergartens or schools. Cheerful colours create a child-friendly ambience. Washbasins and mirrors with apple green accents now provide additional scope for coloured design in the children's bathroom.

Tumbler Racks

Practical and Flexible

The practical tumbler rack can be extended by four additional slots as and when required by an add-on module. The tumbler rack is optionally available with towel hooks. The opening of the shielded handtowel hook is positioned facing the wall for safety. For individualisation and simple allocation of the tumblers, additional writable stickers or pictograms with motifs are available. Like the tumblers, the stickers are dishwasher safe. HEWI tumbler racks conform to the requirements of DGUV Guidelines 82 «Child daycare centres».

Washbasins and Mirrors

Functional and Safe

The washbasins are available in two different sizes: As a single washbasin or as a practical double washbasin. The narrow edge and compact design allow even small children to reach the fitting effortlessly. Gentle radii means no corners or edges on which children could bruise themselves.

The mirrors made of ESG safety glass have a shatter protection film. They are available in two different sizes to match the washbasins. The horizontal stripes in apple green set a fresh accent in the sanitary room.

16 HEWI COLOURS

- 98 (signal white)
- 99 (pure white)
- 97 (light grey)
- 95 (stone grey)

- 92 (anthracite grey)
- 90 (jet black)
- 86 (sand)
- 84 (umber)

HEWI active+

- 98 (signal white)



Tumbler rack with hooks

800.03.400

page 4

- Support plate
- Holder

Tumbler and hooks in 16 HEWI colours



Additional slot tumbler rack with hooks

800.03.410

page 5

- Support plate
- Holder

Tumbler and hooks in 16 HEWI colours



Tumbler rack

800.03.401

page 4

- Support plate
- Holder

Tumbler in 16 HEWI colours



Additional slot tumbler rack

800.03.411

page 5

- Support plate
- Holder

Tumbler in 16 HEWI colours

- 18 (mustard yellow)
- 24 (orange)
- 36 (coral)
- 33 (ruby red)
- 74 (apple green)
- 72 (may green)
- 55 (aqua blue)
- 50 (steel blue)



Mirror
950.01.510 page 7
■ ESG safety glass with shatter protection film



Mirror
950.01.500 page 7
■ ESG safety glass with shatter protection film



Double washbasin
950.12.2056 page 9
Mineral composite, outside apple green



Washbasin
950.12.1016 page 8
Mineral composite, outside apple green



Double washbasin
950.12.205 page 9
Mineral composite



Washbasin
950.12.101 page 8
Mineral composite

Softlink
Item Number

Dimensions in mm / Specification

L2Y9E



800.03.400

- Support plate
 - Holder
- Tumbler and hooks in 16 HEWI colours

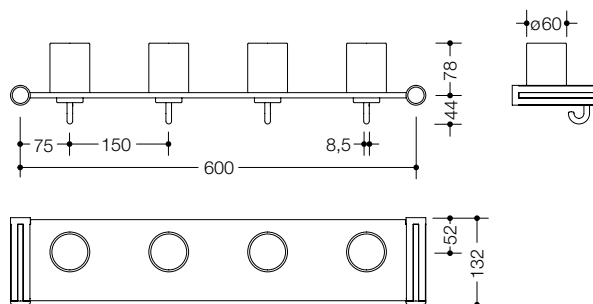

HEWI Tumbler rack with hooks, 4 places

- brackets made of high-quality polyamide in HEWI colour 74 (apple green)
- the tumblers and towel hooks form a colour pair, made of high-quality polyamide
- the coloured hooks are fitted in the given order, from left to right from the user's view
- rack shelf made of robust HPL, surface: silky white, with slight texture
- 150 mm spacing between the slots
- corresponds to the specifications of DGUV Guidelines 82 for children's day care facilities ("Child daycare centres")
- max. static load 20 kg
- retrofittable
- 630 mm wide (c to c 600 mm), 122 mm high, 132 mm deep
- to increase the number of slots, use HEWI extension kit 800.03.410
- for individualisation, additional HEWI pictogram sheets available as blank version for labelling 33.1772E or with motifs 33.1772A, 33.1772B, 33.1772C, 33.1772D

Please advise colour of tumblers and hooks in the desired sequence when ordering.

L2Y9E



800.03.410

- Support plate
 - Holder
- Tumbler and hooks in 16 HEWI colours

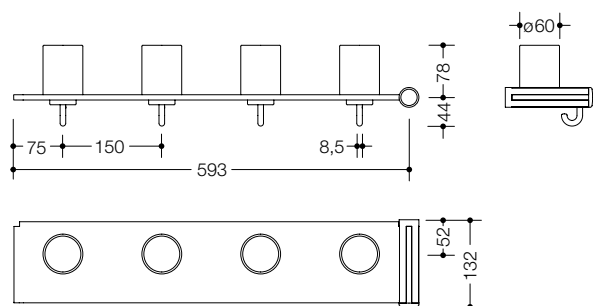

HEWI Additional slot tumbler rack with hooks, 4 places

- for retrofitting on the tumbler rack with towel hooks to add 4 slots
- brackets made of high-quality polyamide in HEWI colour 74 (apple green)
- the tumblers and towel hooks form a colour pair, made of high-quality polyamide
- the coloured hooks are fitted in the given order, from left to right from the user's view
- rack shelf made of robust HPL, surface: silky white, with slight texture
- 150 mm spacing between the slots
- corresponds to the specifications of DGUV Guidelines 82 for children's day care facilities ("Child daycare centres")
- max. static load 20 kg
- retrofittable
- 608 mm wide, 122 mm high, 132 mm deep
- for individualisation, additional HEWI pictogram sheets available as blank version for labelling 33.1772E or with motifs 33.1772A, 33.1772B, 33.1772C, 33.1772D

Please advise colour of tumblers and hooks in the desired sequence when ordering.

33.1772...
41382
477.90.040

HEWI Pictogram-set see page 6
HEWI Tumbler see page 6
HEWI Hook see page 6

Softlink
Item Number

Dimensions in mm / Specification

L2Y9E

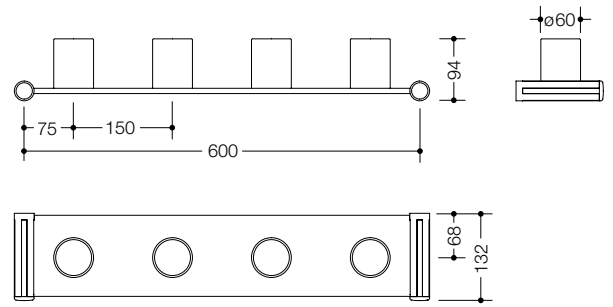

800.03.401

HEWI Tumbler rack, 4 places

- brackets made of high-quality polyamide in HEWI colour 74 (apple green)
- rack shelf made of robust HPL, surface: silky white, with slight texture
- 150 mm spacing between the slots
- corresponds to the specifications of DGUV Guidelines 82 for children's day care facilities ("Child daycare centres")
- max. static load 20 kg
- retrofittable
- 630 mm wide (c to c 600 mm), 94 mm high, 132 mm deep
- to increase the number of slots, use HEWI extension kit 800.03.411
- for individualisation, additional HEWI pictogram sheets available as blank version for labelling 33.1772E or with motifs 33.1772A, 33.1772B, 33.1772C, 33.1772D)

Support plate
 Holder
Tumbler in 16 HEWI colours

Please advise colour of tumblers when ordering.

L2Y9E

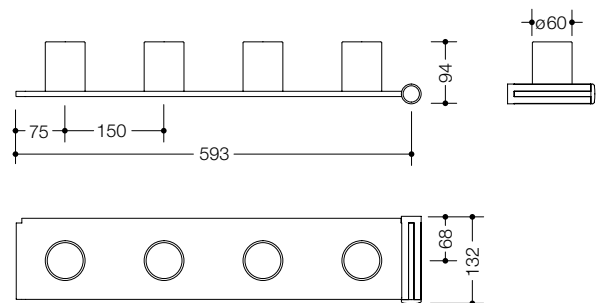

800.03.411

HEWI Additional slot tumbler rack, 4 places

- for retrofitting to the tumbler rack to add 4 slots
- brackets made of high-quality polyamide in HEWI colour 74 (apple green)
- tumblers made of high-quality polyamide
- rack shelf made of robust HPL, surface: silky white, with slight texture
- 150 mm spacing between the slots
- corresponds to the specifications of DGUV Guidelines 82 for children's day care facilities ("Child daycare centres")
- max. static load 20 kg
- retrofittable
- 608 mm wide, 94 mm high, 132 mm deep
- for individualisation, additional HEWI pictogram sheets available as blank version for labelling 33.1772E or with motifs 33.1772A, 33.1772B, 33.1772C, 33.1772D)

Support plate
 Holder
Tumbler in 16 HEWI colours

Please advise colour of tumblers when ordering.

16 HEWI Colours

98	99	97	95	92	90	86	84
18	24	36	33	74	72	55	50

**33.1772...
41382**

HEWI Pictogram-set see page 6
HEWI Tumbler see page 6

Softlink
Item Number

Dimensions in mm / Specification

Z0K4E



33.1772...

- ...A
- ...B
- ...C
- ...D
- ...E
- ...Z

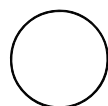

↔ ø 40 ↔

HEWI Pictogram-set

- multicolored
- e. g. for tumbler diameter 40 mm
- 25 different designs per series, self-adhesive

set, eating and drinking
set, vehicles
set, toys
set, animals
blank set, white without design, for individual lettering or decorating

Pictogram sheet containing 20 additional motifs - 5 different motifs per series from ...A to ...D inclusive



41382

In 16 HEWI Colours

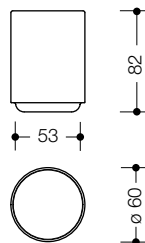

HEWI Tumbler

- ø 60 mm, 82 mm high
- made of high-quality polyamide

C1K4E



477.90.040

In 16 HEWI Colours

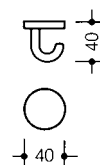

HEWI Coat hook

- can be installed under shelf
- concealed screw fitting to prevent unauthorised removal
- 40 mm high, rose ø 40 mm
- made of high-quality polyamide

Supplied without screws and plugs.

Softlink
Item Number

Dimensions in mm / Specification

T6Y6E



950.01.500

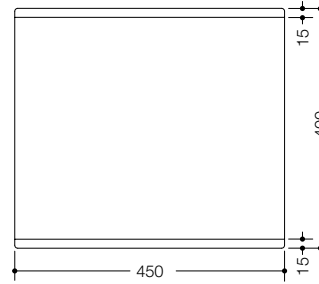

HEWI Mirror

- rectangular with coloured, back-painted horizontal edge
- mirror made of ESG safety glass with shatter protection film
- back-painting in HEWI colour 74 (apple green)
- concealed fixing
- with safety catch
- 450 mm wide, 400 mm high, mirror 4 mm thick
- mirror surface 450 mm wide, 370 mm high

■ ESG safety glass with shatter protection film

T6Y6E



950.01.510



HEWI Mirror

- rectangular with coloured, back-painted horizontal edge
- mirror made of ESG safety glass with shatter protection film
- back-painting in HEWI colour 74 (apple green)
- concealed fixing
- with safety catch
- 850 mm wide, 400 mm high, mirror 4 mm thick
- mirror surface 850 mm wide, 370 mm high

■ ESG safety glass with shatter protection film

16 HEWI Colours

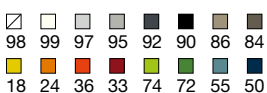

 **O507E**

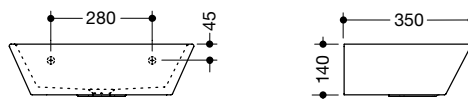

950.12.101

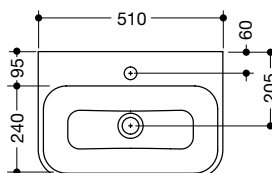

HEWI Washbasin

- especially suitable for child daycare centres or guest toilet
- made of mineral composite with non-porous surface, alpine white
- rectangular basin with large radii
- without overflow
- prepared for single hole mixer tap
- 510 mm wide und 350 mm deep
- for hanger bolt fixing
- weight capacity to EN 14688
- high water temperature (e.g. for thermal disinfection): resistant to thermal shock up to 65 °C, resistant up to 80 °C for an exposure period of 5 minutes
- CE marking according to Construction Products Regulation No. 305/2011

Mineral composite

 **O507E**

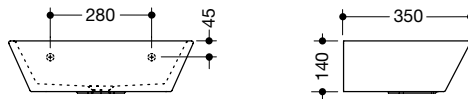

950.12.1016

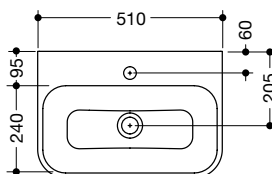

HEWI Washbasin

- especially suitable for child daycare centres or guest toilet
- made of mineral composite with non-porous surface
- two-coloured: alpine white and HEWI colour 74 (apple green)
- rectangular basin with large radii
- without overflow
- prepared for single hole mixer tap
- 510 mm wide und 350 mm deep
- for hanger bolt fixing
- weight capacity to EN 14688
- high water temperature (e.g. for thermal disinfection): resistant to thermal shock up to 65 °C, resistant up to 80 °C for an exposure period of 5 minutes
- CE marking according to Construction Products Regulation No. 305/2011

Mineral composite, outside apple green

Softlink
Item Number

Dimensions in mm / Specification

 **O507E**



950.12.205

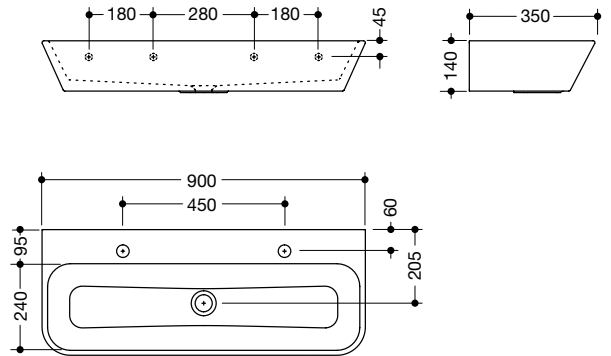

HEWI Double washbasin

- especially suitable for child daycare centres
- made of mineral composite with non-porous surface, alpine white
- rectangular basin with large radii
- without overflow
- prepared for single hole mixer taps
- 900 mm wide and 350 mm deep
- for hanger bolt fixing
- weight capacity to EN 14688
- high water temperature (e.g. for thermal disinfection): resistant to thermal shock up to 65 °C, resistant up to 80 °C for an exposure period of 5 minutes
- CE marking according to Construction Products Regulation No. 305/2011

Mineral composite

 **O507E**



950.12.2056

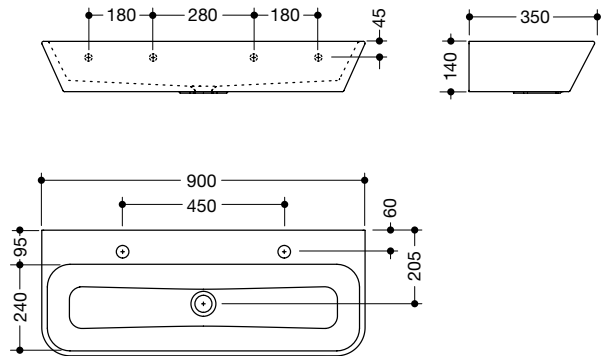

HEWI Double washbasin

- especially suitable for child daycare centres
- made of mineral composite with non-porous surface
- two-coloured: alpine white and HEWI colour 74 (apple green)
- rectangular basin with large radii
- without overflow
- prepared for single hole mixer taps
- 900 mm wide and 350 mm deep
- for hanger bolt fixing
- weight capacity to EN 14688
- high water temperature (e.g. for thermal disinfection): resistant to thermal shock up to 65 °C, resistant up to 80 °C for an exposure period of 5 minutes
- CCE marking according to Construction Products Regulation No. 305/20111

Mineral composite, outside apple green

General Terms and Conditions of Sale

I. Applicability of the General Terms and Conditions of Sale

1. These General Terms and Conditions of Sale shall apply to all current and future contracts and services pertaining mainly to the supply of goods to the customer.

2. The customer's conflicting or divergent Terms and Conditions of Business shall not obligate us even if we do not expressly object to these Terms and Conditions of Business and, irrespective of such terms and conditions, perform services or accept customer services without reservation.

3. Agreements that diverge from our General Terms and Conditions of Sale shall be recorded in writing. Failing this, our General Terms and Conditions of Sale shall retain their validity.

II. Entry into the Contract, Applicability of the Offers

1. Our offers shall be subject to change and valid only for a reasonable period.

2. Agreements, in particular, oral collateral agreements, commitments, guarantees and other assurances made by our salespersons, shall only become binding if they have our written confirmation and are based on these General Terms and Conditions of Sale.

3. The documents that form part of the offer, such as drawings, illustrations, technical data, references to standards and statements in promotional material shall not constitute indications of quality, assurances of properties or guarantees unless they have been expressly designated as such in writing. We reserve the right to make design changes in the interests of technological progress.

4. The customer shall ensure to the full extent that our products are fit for the purpose intended by the customer. If the ordered goods are not to be used exclusively for ordinary purposes or deployed under unusual conditions, conditions that are particularly relevant for safety matters or such as make increased operational demands, the customer shall be obliged to inform us of this before entering into the contract.

III. HEWI's Obligations

1. We shall be obliged to supply in accordance with standard commercial tolerances in respect of type, quality and packaging.

2. The delivery dates quoted by us shall be anticipated dates and refer to the time of the outbound delivery, i.e. departing from the Bad Arolsen plant.

3. We shall adhere to delivery dates wherever possible, providing the customer provides the documents or releases to be procured in good time, makes advance payments as stipulated in the agreement and fulfils all other obligations incumbent upon him in a timely manner. We shall be entitled to fulfil contractual obligations after the designated delivery date if the customer is informed

of the delivery date overrun and advised of a period of time for subsequent performance, unless the subsequent performance is unacceptable to the customer or the customer objects to the offer of subsequent performance within a reasonable period. In the event of subsequent performance, we shall reimburse any additional customer expenditure that was demonstrably necessary as a result of the delivery date overrun, providing we are liable for damage pursuant to the provisions contained in Clause VI.

IV. Prices

The prices that have been confirmed to the customer in writing and, in the absence thereof, the prices valid on the day of dispatch shall apply. All prices shall be ex Bad Arolsen plant, without cash discount or other price discounts and exclusive of VAT. Additional ancillary services (e.g. freight, packaging or shipping costs) shall be charged separately.

V. Warranty

1. Subject to the recourse rules pursuant to Sections 478 and 479 of the German Civil Code, all claims by the customer on account of delivery of defective goods shall become time-barred one year after commencement of the statutory limitation period.

2. The customer shall inspect the supplied goods immediately and in all respects for identifiable defects in quality, quantity or other kind and inform us in writing of complaints within 5 working days, providing an exact description of the type and extent of the defect. If the customer does not comply with his immediate duty to inspect the goods and give notice of defects with regard to identifiable defects in quality, the supplied goods shall be regarded as approved with regard to identifiable defects in quality, whereby the assertion of corresponding warranty claims including consequential damage shall be excluded.

3. If the customer himself attempts to remove defects in quality or engages third parties so to do without our agreement, we shall be released from the warranty obligation, unless said attempts are carried out properly.

4. In the event of legitimate, immediate notification of defects, we shall, at our option, render subsequent performance either by removing the defect or by supplying goods that are free of defects. If the subsequent performance is unsuccessful, the customer shall be entitled, in accordance with the statutory provisions, to demand rescission or price reduction.

5. We shall only bear expenditure relating to subsequent performance if it is appropriate in the individual case, particularly in comparison to the purchase price of the goods. We shall not bear expenditure that is incurred due to the goods being transported to a location registered or regional office, unless this complies with their use as stipulated in the contract.

6. We shall provide no warranty for defects in quality that arise due to inappropriate or improper use, incorrect assembly or commissioning by the customer or third

parties, natural wear and tear, incorrect or negligent handling; nor shall we warrant the consequences of improper modifications to the goods undertaken without our consent.

7. Further claims on account of defects in quality shall be excluded in accordance with Clause VI. This shall apply, in particular, to claims to compensation for damage that has not arisen on the goods themselves.

VI. General Limitation of Liability

1. Our liability for damages and for compensation of wasted expenditure, on whatever legal grounds, shall be limited to gross negligence and wilful intent. This shall also apply to negligence of duty on the part of our legal representatives and vicarious agents.

2. In the case of ordinary negligence, we shall only be liable, on whatever legal grounds, in the event of breach of material contractual obligations. The amount of any claim for damages shall be limited, in this case, to compensation for the typical, foreseeable damage. Material contractual obligations shall be those whose fulfilment enables proper enforcement of the contract and on whose observance the customer regularly relies and may rely. The customer shall be obliged to advise us in writing, prior to entering into the contract, of particular risks, atypical possibilities of damage and unusual amounts of damage. Liability for any consequential damage that goes beyond this, lack of economic success, indirect damage, lost profit and damages from third-party claims shall be excluded.

3. No limitation of liability shall apply in the event of wilful intent or gross negligence or claims relating to injury to life, limb or health or for claims arising from the Produkthaftungsgesetz (Product Liability Act) and other mandatory liability provisions.

4. If an item defined solely on the basis of its category is the object of the purchase agreement, our liability shall also be determined in this case according to the aforementioned rules; liability irrespective of fault shall be excluded.

VII. Guarantees

Guarantees requested by customers must always be specifically designated as such in the written order acknowledgement. In particular, catchword-based designations, reference to generally accepted standards, the use of trademarks or quality marks or the submission of patterns or samples shall not by itself give rise to the assumption of a guarantee or assurance. In the case of custom productions that are executed in accordance with customer drawings or concepts, we shall only be liable for raw material defects and processing according to the state of the art when the order is placed. A performance guarantee shall also be. A performance guarantee shall also be excluded if we have influenced product development as a result of customer proposals or elaborations.

VIII. Terms of Payment

1. Our invoices shall become due within 14 days with 2% discount or within 30 days net, from the date of invoice in each case. The date on which our account is credited shall be deemed to be the effective date of payment.

2. If the due date for payment is exceeded, the customer shall be deemed to be in default without the need for a reminder. In the event of the customer's default, we shall be entitled to charge interest in the amount of the relevant bank rates for HEWI General Terms and Conditions of Sale General Information overdrafts but, in any case, no less than 8 percentage points above the base interest rate. We reserve the right to claim further damages caused by default.

3. Cheques shall be accepted only subject to full performance. Discount and/or collection costs shall be charged to the buyer.

4. In the event of default on payment or cheque protests, all existing claims shall fall due immediately, and we shall be entitled to require the customer to pay in advance for deliveries en route to him or to refuse delivery until payment has been made in full.

IX. Retention of Title

1. Supplied goods shall remain our property until all our claims against the customer, on whatever legal grounds, including principal and subsidiary claims that will become due only in the future, have been settled in full. Where a running account is operated, the retention of title shall apply to the corresponding balance.

2. The customer may sell the goods subject to retention of title only if he is not in default of payment and assigns in advance his claim to payment against the purchaser arising from the resale in the amount of our outstanding claims.

3. The customer shall, by way of security, hereby irrevocably assign to us in the full amount any claims against his purchasers to which he is entitled as a result of the sale of the goods subject to retention of title, together with all ancillary rights. The advance assignment shall be accepted by us upon delivery of the goods to the customer. The customer shall, at our request, be obliged to provide written acknowledgement of the transfer of his claims and rights against third parties or to disclose said transfer to third parties. If the customer collects a claim to which we are wholly or partly entitled on the aforementioned grounds, he shall be acting only as a debt collector in this respect and shall be obliged to remit to us the amount collected up to the level of our claims.

4. Any machining or processing of the goods shall be carried out for us as manufacturers pursuant to Section 950 of the German Civil Code, without our incurring any obligations. If the goods are combined or mixed with other goods, we shall be entitled to coownership of the new item in the proportion of the invoice value of the goods subject to retention of title to the invoice value of the other goods used or newly created.

5. In the event of cheque-based payment, the retention of title shall continue to apply until our account has been irrevocably credited.

6. In the event of third-party appropriation of the goods supplied by us or the goods newly created from combination or mixture with our goods, particularly in the event of seizures, the exercise of contractors' liens or the institution of insolvency proceedings, the customer shall be obliged to inform us thereof immediately in writing and to draw the attention of third parties to the existing retention of title without delay. The same shall apply to thirdparty garnishments on claims of the customer, providing they have been assigned to us in accordance with Clause IX. 3.

X. Returns

1. Goods sold without defects shall be taken back on a voluntary basis (goods returns) and must be agreed with us separately. There shall be no entitlement hereto. If we agree to take back the goods, the following provisions shall apply.

2. Our order centre must generally be given written notification of any goods returns, such notification quoting the article number and order quantity as well as delivery note and invoice number.

3. Only such returns as have previously received a returns form, including returns number, from us and have been assigned the form when returned shall be accepted. The customer shall bear any costs involved in the return of the goods as well as the risk of deterioration or accidental destruction of the goods. Goods that are sent to us freight collect or without a returns form shall not be accepted and shall be returned at the sender's expense.

4. The possibility of goods returns shall be limited exclusively to those products that the customer has purchased directly from us and whose delivery date is no more than 1 year in the past. The obligation to provide documentary proof thereof shall rest with the customer.

5. Unsalable goods (e.g. goods that no longer feature in our catalogue, parts or products manufactured to dimensions, which have undergone technical modifications in the meantime) shall likewise be precluded from return.

6. The goods return deadline for returns approved by us shall be 4 weeks from notification of the approval declaration. Returns received after this date shall no longer be accepted and shall be returned at the sender's expense and risk.

7. Immaculate, properly packaged, resalable returns approved by us in accordance with the aforementioned conditions shall be credited to the customer less 25% of the net value of the goods. Furthermore, a flat-rate processing charge of EUR 25.00 shall be deducted for each return. The return shall be settled by means of a credit note. Where an invoice deduction has not been agreed, we shall be forced to make a charge of EUR 25.00 in addition to the processing costs incurred.

Where the net value of the goods is under EUR 25.00 per delivery note or invoice number, no credit note shall be issued.

XI. Model Costs

Payments that the customer makes to us as model or tool costs shall be regarded as an irrecoverable subsidy and shall not be set off against the customer's payment obligations. The models or tools prepared by us shall become our full and exclusive property.

XII. Printing Errors

We shall not be liable for any printing or labelling errors in catalogues or price lists. All representations and measurements shall be non-binding. We express the right to make changes. The same shall apply to design changes that are made in the interests of technical progress.

XIII. Place of Fulfilment, Venue, Applicable Law and Prohibition of Setoff

1. The place of fulfilment for all obligations arising from the legal relationships between ourselves and the customer shall be Bad Arolsen.

2. Bad Arolsen shall be deemed to have been agreed as the venue for all legal disputes, including litigation in respect of cheques and bills of exchange.

3. The law of the Federal Republic of Germany shall be solely applicable to the contractual relationship between the customer and ourselves.

4. The customer may set off against our claims only if the customer's counterclaim is undisputed by us or if the existence of the counterclaim has become res judicata.

XIV. Severability Clause / Applicability

1. If provisions in these General Terms and Conditions of Sale are or become wholly or partly invalid, this shall not affect the validity of the remaining provisions. The Parties hereto shall then be required to replace the invalid ruling by a valid provision that comes closest to the economic intent and purpose of the invalid ruling. The same shall apply in the event of an unidentified lacuna.

2. The foregoing General Terms and Conditions of Sale (as at 5 September 2007) shall be applicable to all contracts formed from 1 April 2008 onwards and shall completely replace our Terms and Conditions of Business that have been in effect hitherto.

HEWI

GERMANY

HEWI Heinrich Wilke GmbH
Postfach 1260
34442 Bad Arolsen
Tel.: +49 5691 82-0
Fax.: +49 5691 82-319
international@hewi.com

UNITED KINGDOM

HEWI (UK) Limited
Holm Oak Barn, Beluncle Halt
Stoke Road, Hoo
Rochester, Kent ME3 9NT
Phone: +44 1634 258200
Fax: +44 1634 250099
info@hewi.co.uk
www.hewi.co.uk

www.hewi.com