



Delta Membrane Systems Ltd



Pre-Applied Hydro-Reactive  
Waterproofing Systems

[www.deltamembranes.com](http://www.deltamembranes.com)

# CONTENTS

DELTA AMPHIBIA	1
ABOUT US	2-3
PROJECTS	4-5
BRITISH STANDARDS	6
BEST PRACTICE	7
WATERPROOFING DESIGN	8
DESIGN AND BUILD PHILOSOPHY	9
DELTA AMPHIBIA 1.3mm	10-11
DELTA AMPHIBIA 1.6mm	12-13
ANCILLARIES	14
BEFORE CASTING	15
INSTALLATION	16
TYPICAL APPLICATION	17
TECHNICAL DRAWINGS	18-19
DEFINITIONS	20-21

# DELTA AMPHIBIA

## Delta Amphibia is a Pre- & Post- Applied Fully Bonded Waterproofing Membrane with Reactive Core

Delta Amphibia is a hydroreactive, self-healing, self-sealing multi-layer waterproofing system which can be applied both vertically and horizontally.

Made from 4 unique layers



### TIGHT BARRIER

Fully watertight layer

### CORE

Self-sealing and self-healing super-expanding safety layer

### ACTIVE BARRIER

Expansion controlled hydro-reactive layer for self-sealing over overlaps

### BOND

Fast-fastening, non-woven geotextile control layer for bonding with concrete



We are one of the UK's leading suppliers of structural waterproofing systems, basement drainage systems (sump pumps) and drainage products and the UK's leading manufacturer of Type C, cavity drainage membranes.

Delta Membrane Systems Limited provides a full range of waterproofing solutions suitable for all new, retrofit and refurbishment construction.

We offer a comprehensive range of ground gas protection solutions along with our structural waterproofing solutions. From our Ground Gas Protection membranes to waterproofing systems, our product range is designed to deal with all ground gases, contaminants, and waterproofing related projects.

With over 125 years of manufacturing experience Delta is an impeccable partner on every project. Our skills have been mastered through experience in the waterproofing industry. Delta's trusted Technical Team provide the best solutions for architects, developers, and homeowners to protect properties against the ingress of water and damp.

We help from concept to completion. Our hands on approach and knowledge are what sets us apart.



## INNOVATION MANUFACTURER DESIGN SOLUTION



We have a dedicated, multi-disciplinary team creating, innovative, robust, and reliable waterproofing solutions. We strive for excellence and manufacturing synergy, utilising each team member's individual skills and own unique approach on design, collaborating to achieve exceptional results.



The Delta Specification team works with architects, designers, contractors, and engineers. Our team provides full consultation services, including CSSW Specification Reports. We offer advice on how Delta specifications can promote the successful outcome of any project.



With extensive experience in the field of structural waterproofing, we draw upon knowledge and expertise to offer a totally flexible on-site support. As part of our commitment to innovate through the development of best practice, our on-site support will complement any existing design and installation team. We aim to help support and develop the skills of your technicians and, if required, will also provide bespoke onsite training for your technical teams.

## A NOTE FROM THE DIRECTORS

### David J Symes

MANAGING DIRECTOR

“As part of our vision, Delta aim to make a real difference to the UK construction and waterproofing industry and promote best practices. Every manufacturer should manufacture products through economically-sound processes that minimize negative environmental impacts whilst conserving energy and natural resources. Achieving sustainability in manufacturing requires a comprehensive view spanning not just the product and the manufacturing processes, but also the entire supply chain, including product lifespan.”



“The UK building materials industry is a healthy and competitive one, with plenty of big named brands vying for a customer’s attention. Invariably all will have differences and it’s vitally important to ensure you’re not comparing Apples with Oranges. ”

### Kevin Dodds

MANAGING DIRECTOR

“We strive to understand what clients want and apply this to the service(s) we offer and the bespoke solutions we develop. This is underpinned by superior quality products with substantial capabilities, which opens-up our expertise to every client, regardless of size of project. The Delta Team’s dedication and professionalism are truly remarkable, with work ethics which inspire. ”



---

**Building for the future is a privilege, and we’ll approach it wisely and responsibly**

---

### ALWAYS HAPPY TO HELP

Do you have questions about a project, product, or application? In an ever-changing industry where reduced risk and higher quality is required, you need a waterproofing design partner that is proactive and dedicated to help you keep up with new technologies and solutions to ensure your projects thrive. Whatever the needs of your business, you can rely on the #DeltaTeam to ensure you get the right advice, support, and practical help at exactly the right time to keep you ahead of the competition. Contact us on 01992 523 523 or email [info@deltamembranes.com](mailto:info@deltamembranes.com)



There are many different approaches to structural waterproofing. The construction methods will in part contribute to the specification of types of waterproofing systems and may also determine the overall structural waterproofing strategy

Structural Waterproofing falls into types

3

With 3 grades

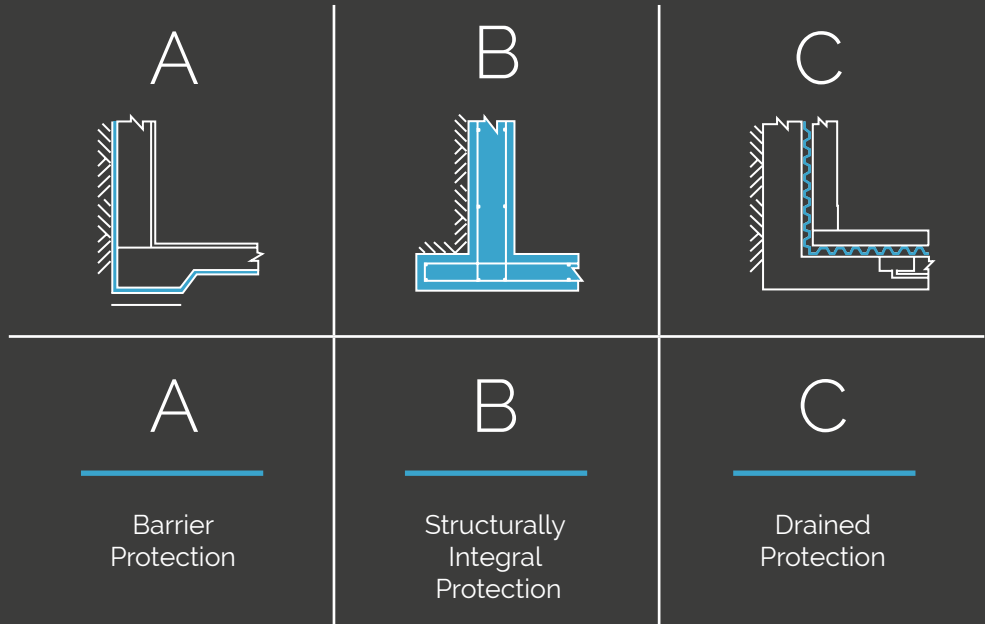

## New Construction

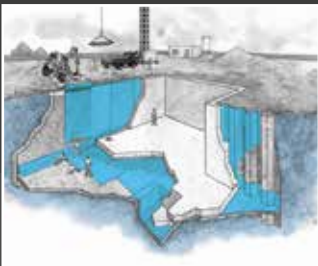

## Refurbishment of Existing Construction

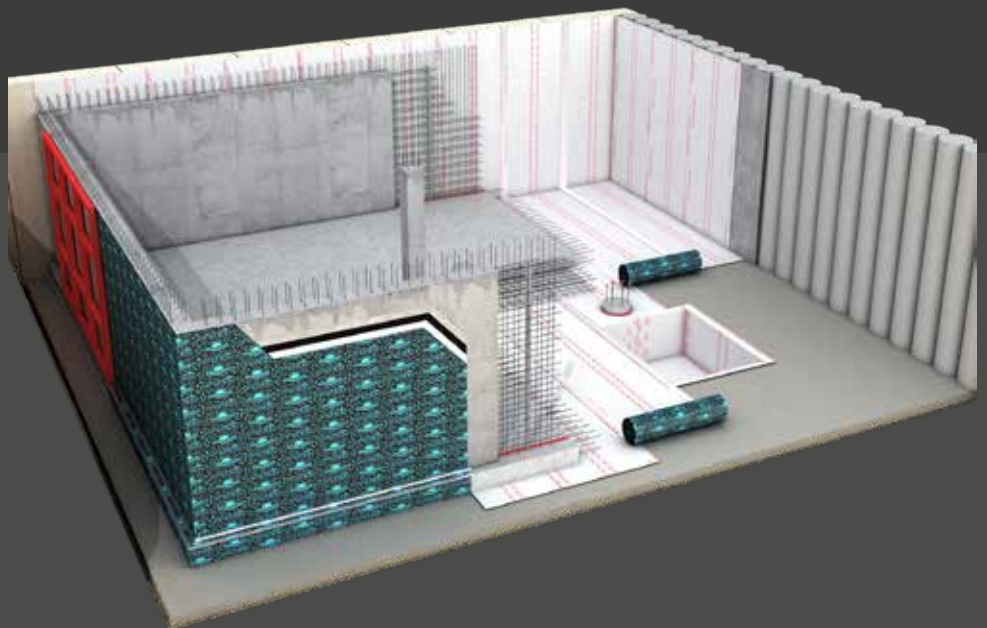
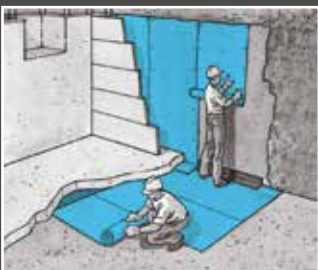

SCHOOLS



COMMERCIAL & RESIDENTIAL BUILDINGS



D  
7



UNDERGROUND CAR PARKING

MUSEUMS



LEISURE FACILITIES



RETAIL UNITS & WAREHOUSES



TUNNELLING



INSULATED FORMWORK CONSTRUCTION



ARCHIVES/LIBRARIES/VAULTS



HOSPITALS



LISTED BUILDINGS



# Below Ground Waterproofing Solutions



Established in 1901 the BSI Group (formerly the Engineering Standards Committee), sought to standardise the types of steel manufactured in Great Britain in order to assist with competitiveness and efficiency. Over decades these standards have been developed to cover numerous aspects of the engineering/building sector including engineering methodologies, quality, safety, systems, and security.

## BS 8102:2022 Protection of below ground structures against water ingress. Code of practice

NHBC Chapter 5.4 gives guidance on meeting the Technical Requirements for the waterproofing of basements and other structures below, or near to, ground level

- Design standards
- Compliance
- Statutory requirements
- Provision of information
- Waterproofing
- Ground conditions
- Structural stability
- Design considerations
- Thermal insulation and vapour control layers
- Waterproofing systems and surface finishes
- Rainwater drainage
- Handling, storage, and protection

BS 8102:2022 was launched March 2022. British Standard 8102 'Code of practice for protection of below ground structures against water from the ground' was first publicised in 1990 with the second edition being publicised in November 2009. It should be noted that BS8102:2009 is now superseded and withdrawn.

BS 8102 is a standard designed to protect the consumer. BS 8102 has been formulated to ensure the correct waterproofing solution has been selected and adhered to during the build process and reinforces the importance of skilled, competent waterproofing specialists.

BS 8102 gives recommendations and provides guidance on methods of dealing with and preventing the entry of water from surrounding ground into a structure below ground level.

It covers the use of:

- a) Waterproofing barrier materials applied to the structure
- b) Structurally integral watertight construction
- c) Drained cavity construction

BS 8102 further covers (but is not limited to):

- Types of construction
- Water tables classification
- Scope and limitations
- Site evaluation
- Water-resistant design philosophies
- General construction issues
- Remedial measures







## BEST PRACTICE

Best practice defines a process, method(s), or technique(s) which when executed, effectively leads to enhanced project performance.

Best practice is based on the adoption of regulations, standards, specifications, coordinating methods and procedures that are to be used, benchmarking, compatibility and quality of products and compliance of a particular product, service, or material.

Best practices maintain quality.

"At our very core, we are driven by a diverse team that is dedicated to innovation and is passionate about creating integrated, maintainable and robust solutions".



## REGISTERED INSTALLER NETWORK

As manufacturers of quality systems, it is imperative to work with quality installation companies. At Delta, we pride ourselves that we've built a team of highly qualified, reliable, specialist approved Registered Installers.

Delta Registered Installers Network are an elite group of experienced Delta System installers who share our values – a dedication to quality, authenticity and exceptional customer services.

Our Delta Registered Installer Partners all have extensive experience of working with and installing Delta Systems, meaning you can be confident of a quick, efficient installation, carried out with the minimum of disruption and fuss.

All Delta Registered Installers adhere to a strict-criteria and are required to attend training as well as demonstrating quality of workmanship before accreditation of the Registered Installer title, resulting in a meaningful scheme that provides unrivalled technical excellence.



## PRODUCT GUARANTEES

Delta Membrane Systems Limited offer a 10-year Product Guarantee on all Amphibia membranes, seals and fixings when the Delta Amphibia system has been installed by a Delta Registered Installer.

# WATERPROOFING DESIGN

A Waterproofing Design Specialist provides expertise in structural waterproofing.

A Waterproofing Design Specialist should:



- Be suitably qualified and experienced with the type and size of the proposed project
- Be capable of devising solutions that accommodate the project constraints and needs with an understanding of construction forms and sequencing
- Provide the design team with information and guidance that assists and influences the design, installation, and future maintenance of the waterproofed structure
- Be able to list the principal considerations for a robust waterproofing design
- Offer knowledge on waterproofing systems available
- Have an in-depth understanding of BS 8102 and its requirements
- Have desk top study & risk assessment knowledge – these should form part of any Designers Report and Waterproofing Design
- An understanding of sources of water (such as how it flows through the soil and interacts with the structures)
- Have structural knowledge
- Have knowledge of Ground Gases
- Geotechnical knowledge (to be able to understand the implications of a soil report)
- Have the ability to produce a Design Report, Method Statements and Waterproof Design drawings

---

The best way to  
protect for the  
future is to  
create it!

---

BS 8102 Code of Practice for the Protection of Below Ground Structures Against Water from the Ground, provides guidance on the methods which should be adopted to deal with and prevent the entry of water from the ground into a structure that is below ground level. It is widely referred to and used in basement waterproofing with reference to:

- Adoption of a design team
- Water table classification
- Defects and remedial measures

Our Design and Build Philosophy is quality driven, working with architects and trades alike, putting at the forefront construction considerations to ensure buildability, functionality, and maintainability. The result of this single approach is a consistent, complete, and quality design that is hard to equal.

In a world of hasty construction that can at times neglect attention to detail, we take pride in our passion to improve standards within the industry to develop solutions and successful installations which offer a life cycle to equal and beyond current expectations. Delta's designs focus on a life-cycle oriented design philosophy, addressing life-cycle concepts and methods, deterioration and damage evaluation, life-cycle performance indicators, inspection and maintenance procedures all implemented in design practice. We work with our customers to establish a robust functioning design, this fine-tuning during the design processes reduces project failure. Whether designing a waterproofing solution for a new home or reviving and modernizing an existing space, our designs are built to last and to be maintainable. By embracing the design-build model, we save our clients stress, time, and money; we can remove the bidding step from the construction process and work with our own well-established team of Registered Installers.

Our design philosophy embraces innovation and creating solutions that minimize client risk, foster collaboration, and partnership, and ultimately delivers the client with a waterproofing system which will resist to the passage of water.

Well compacted concrete is inherently water resistant and with enough depth can effortlessly block water ingress from structures below ground. But why do so many concrete structures leak? It is not the concrete, which is leaking but areas such as service penetrations, cracks/joints/ducts which are not adequately waterproofed which allow for water ingress. Much of the failure associated with structural waterproofing is attributed to insufficient consideration of details within the waterproofing design.



# DELTA AMPHIBIA 1.3mm

## Description

Delta Amphibia 1.3mm Pre-Applied membrane is a co-extruded multilayer waterproofing membrane.

This robust, tough but flexible waterproofing membrane is ideal for all construction applications. Delta Amphibia is an EPDM waterproof membrane available in two widths, reactive to contact with water, self-repairing, self-sealing and self-fastening to concrete.

Delta Amphibia offers differentiated function for total water tightness of underground structures against water seepage. Moreover, it is provided with a calibrated non-woven fabric on the inner face/side in contact with fresh concrete which allows the mechanical adhesion of the membrane to the structure.



## Features

- Cold application with easy visual inspection of correct installation
- Resistant to groundwater
- Self-sealing overlapping's
- Absolute impermeability, with no side seepage of water
- High puncture resistance
- Immediate mechanical protection, self-repairing also on accidental holes
- High resistance to hydraulic load
- High flexibility and capacity to bridge cracks
- Total adhesion to the reinforced concrete structure
- Easy passage of connecting reinforcements with self-sealing holes
- Resistance to aggressive natural agents contained in the ground
- Also usable in the presence of salt / Brackish water

## Specification

BS 8102:2022 Protection of below ground structures against water ingress. Code of practice

NBS J40 / 130 – Flexible Sheet Tanking / waterproofing

**DMS 1035** 0.9m x 10m roll

**DMS 1036** 1.8m x 20m roll



## Fields of Application

Waterproofing and protection of concrete underground structures such as residential and commercial buildings, shopping centres, public works etc, which require close and continuous contact between the waterproofing product and structure (foundation slabs and walls, against slurry walls, piles, Berlinese or disposable formwork. It can also be used in other structures such as channels, tanks, purification systems and tunnels.

Anti-damp protection for concrete structures built at ground level such as underfloor screeds.

Delta Amphibia Pre-Applied Membrane 1.3mm can be used:

- Multi-storey underground constructions
- Cellars, garages, tavern, technical rooms, underground rooms in general
- Tunnels, underpasses, and similar infrastructures
- Inground pool waterproofing
- Existing cellars, garages, tavern, technical rooms, underground rooms in general
- Existing tunnels, underpasses, and similar infrastructures
- Elevator pits/lightwells

## Technical Data

Specification	Delta Amphibia 1.3mm	Delta Amphibia 1.3mm
Roll Dimensions	1.80m x 20m (70.87 X 787.40in)	0.9m x 10m (35.43 X 393.70in)
Membrane Thickness	1.3mm	1.3mm
Equivalent Area	36 <sup>2</sup> m (193,75ft <sup>2</sup> )	9 m <sup>2</sup> (96,9ft <sup>2</sup> )
Roll Weight	59kg (130lbs)	15kg (33lbs)
Tolerance	+/- 5%	+/- 5%

# DELTA AMPHIBIA 1.6mm

## Description

Delta Amphibia Pre Applied membrane is a 1.6mm thick co-extruded multilayer waterproofing membrane. This robust, tough but flexible waterproofing membrane is ideal for all construction applications. Delta Amphibia is an EPDM waterproof membrane available in two widths, reactive to contact with water, self-repairing, self-sealing and self-fastening to concrete.

Delta Amphibia offers differentiated function for total water tightness of underground structures against water seepage. Moreover, it is provided with a calibrated non-woven fabric on the inner face/side in contact with fresh concrete which allows the mechanical adhesion of the membrane to the structure.



## Features

- Cold application with easy visual inspection of correct installation
- Resistant to groundwater
- Self-sealing overlapping's
- Absolute impermeability, with no side seepage of water
- High puncture resistance
- Immediate mechanical protection, self-repairing also on accidental holes
- High resistance to hydraulic load
- High flexibility and capacity to bridge cracks
- Total adhesion to the reinforced concrete structure
- Easy passage of connecting reinforcements with self-sealing holes
- Resistance to aggressive natural agents contained in the ground
- Also usable in the presence of salt / Brackish water

## Specification

BS 8102:2022 Protection of below ground structures against water ingress. Code of practice

NBS J40 / 130 – Flexible Sheet Tanking / waterproofing

**DMS 1000** 0.9m x 10m roll

**DMS 1001** 1.8m x 20m roll



## Fields of Application

Waterproofing and protection of concrete underground structures such as residential and commercial buildings, shopping centres, public works etc, which require close and continuous contact between the waterproofing product and structure (foundation slabs and walls, against slurry walls, piles, Berlinese or disposable formwork. It can also be used in other structures such as channels, tanks, purification systems and tunnels.







Anti-damp protection for concrete structures built at ground level such as underfloor screeds.

Delta Amphibia Pre-Applied Membrane 1.6mm can be used:

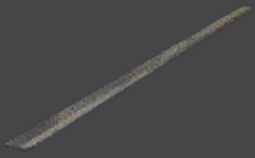
- Multi-storey underground constructions
- Cellars, garages, tavern, technical rooms, underground rooms in general
- Tunnels, underpasses, and similar infrastructures
- Inground pool waterproofing
- Existing cellars, garages, tavern, technical rooms, underground rooms in general
- Existing tunnels, underpasses, and similar infrastructures
- Elevator pits/lightwells

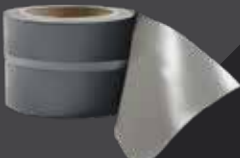
## Technical Data

Specification	Delta Amphibia 1.6mm	Delta Amphibia 1.6mm
Roll Dimensions	1,80m x 20m (70.87 X 787.40in)	0.9m x 10m (35.43 X 393.70 in)
Membrane Thickness	1.6mm	1.6mm
Equivalent Area	36 <sup>2</sup> m (387.5 ft <sup>2</sup> )	9 m <sup>2</sup> (96.9 ft <sup>2</sup> )
Roll Weight	59kg (130lbs)	15kg (33lbs)
Tolerance	+/- 5%	+/- 5%

Delta Amphibia Pressure Line	DMS 1037		<p>Steel straight profile coated on one side with Delta Amphibia membrane</p> <p>Length = 1.5m (59.06in)</p> <p>Height = 5cm (1.97in)</p> <p>Package = 10pcs</p>
Delta Amphibia Pressure Corner 90°	DMS 1038		<p>Steel corner profile coated on one side with Delta Amphibia membrane</p> <p>Length = 1.5m (59.06in)</p> <p>Height = 5cm (1.97in) X 10cm (3.93in)</p> <p>Package = 10pcs</p>
Delta Amphibia Pressure Corner 270°	DMS 1039		<p>Steel corner profile coated on one side with Delta Amphibia membrane</p> <p>Length = 1.5m (59.06in)</p> <p>Height = 5cm (1.97in) X 10cm (3.93in)</p> <p>Package = 10pcs</p>
Delta Amphibia Safety Tape	DMS 1002		<p>One-sided sealing tape typically used for connecting and sealing Delta Amphibia membranes together where they join or overlap</p> <p>Package = 25m roll (984.25in)</p> <p>Roll Size = 60mm x 25m</p>
Delta Amphibia Lap Seal	DMS 1041		<p>Butyl adhesive tape for overlapping joints</p> <p>Package = 10m roll (393.70in)</p> <p>Roll Size = 60mm x 25m</p>
Delta Amphibia Stopper	DMS 1042		<p>Protective stopper to close formwork holes</p> <p>Package = bag 50 pcs</p>
Delta Amphibia Bi Mastic	DMS 1028		<p>High performance deformable adhesive mastic</p> <p>10 unipack box</p> <p>600 cc/ml unipack and nozzle (per unit)</p>
Delta Amphibia AKTI-VO 201	DMS 1004		<p>High performing hydro-expansive mastic for sealing through-elements of Delta Amphibia membranes and sealing and waterproofing passing bodies and general cracks in concrete</p> <p>6 unipack box</p> <p>320cc/ml (per unit)</p>



# BEFORE CASTING

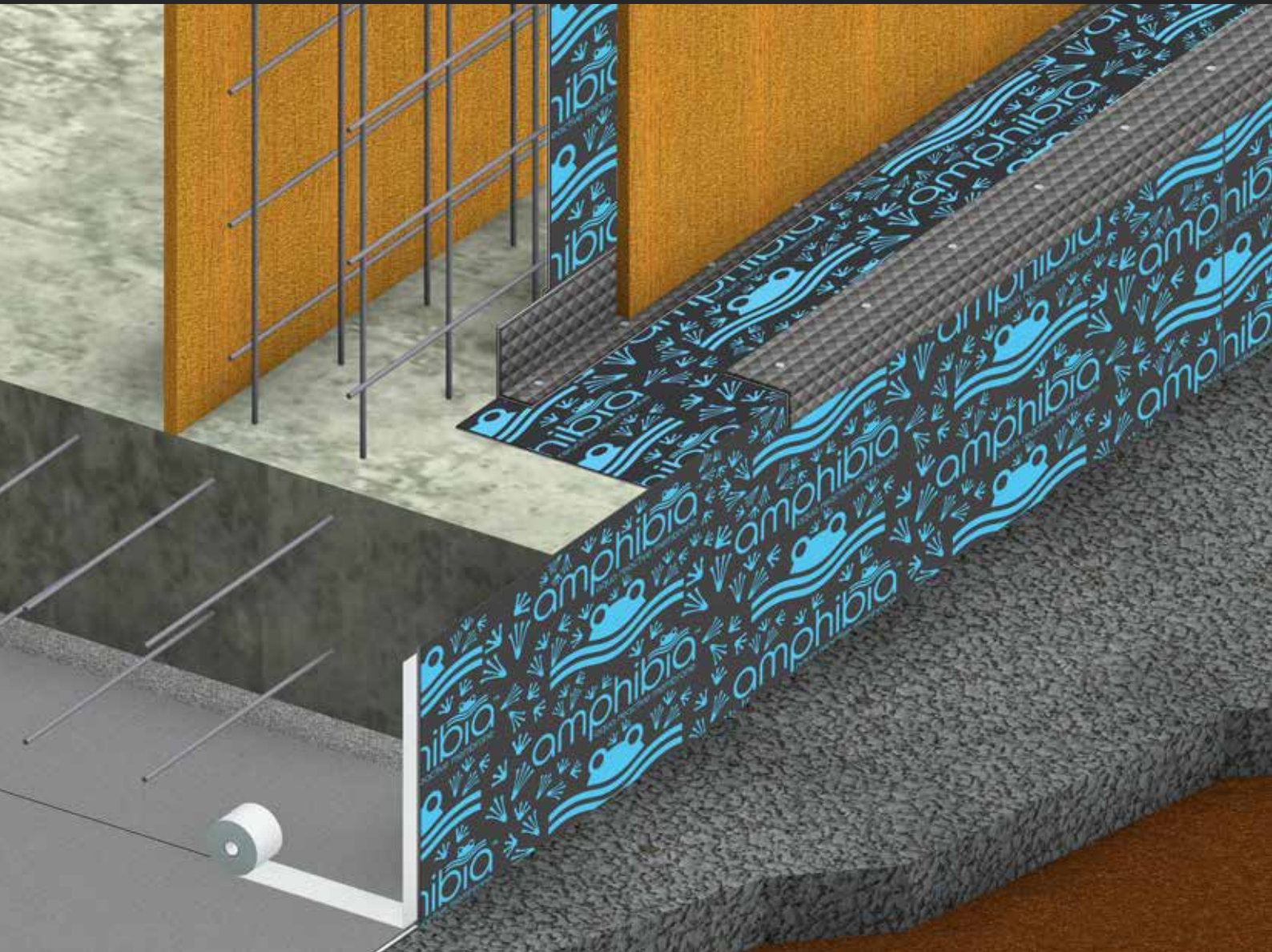

INTERNAL CORNER

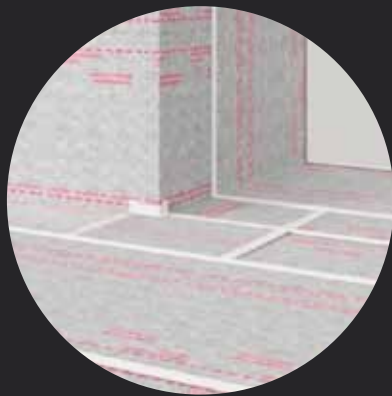

EXTERNAL CORNER



AMPHIBIA EFFECT

# INSTALLATION

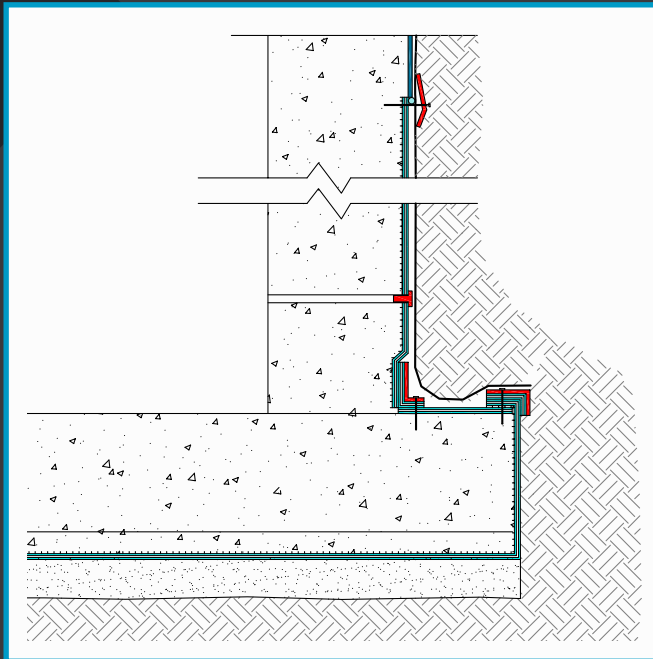

For installation advice and guidance, please refer to Delta Amphibia Installation Guide. The Delta Amphibia Installation Guide has been created to simplify the installation of the Delta Amphibia Membrane system. For more detailed information regarding installations or if you have any questions regarding the Delta Amphibia Membrane system, please do not hesitate to contact us on [info@deltamembranes.com](mailto:info@deltamembranes.com) or 01992 523 523.

For applications not covered in The Delta Amphibia Installation Guide or for site specific technical support, please contact Delta Membrane Systems.

## Pre-Cast

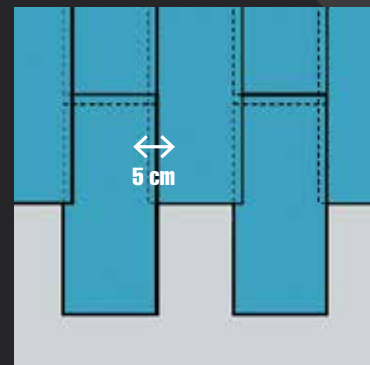
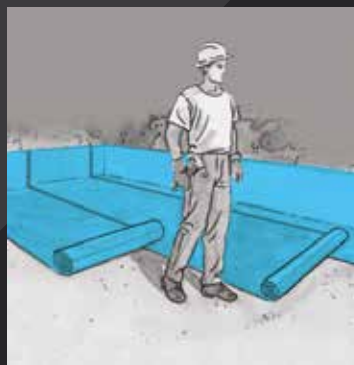
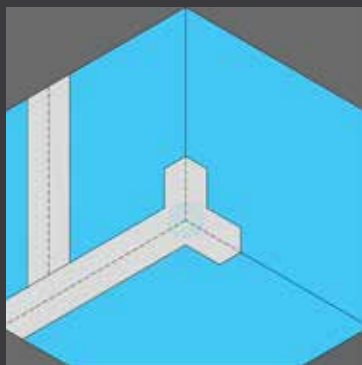

Delta Amphibia is a Type A, external pre-applied waterproofing membrane system that provides a complete and continuous waterproof barrier to the external surface of any below ground structure. The Flexible nature of Delta Amphibia means that it can easily be formed on site to suit the exact design requirements.

Delta Amphibia membranes can be folded and cut in any direction. Delta Amphibia membranes should be installed using Delta Amphibia ancillaries and overlaps sealed using Delta Amphibia Lap Seal.

# TYPICAL APPLICATION

## WATERPROOFING OPEN EXCAVATION

---



## WATERPROOFING BOTTOM-UP WITH DIAPHRAGM WALL

---

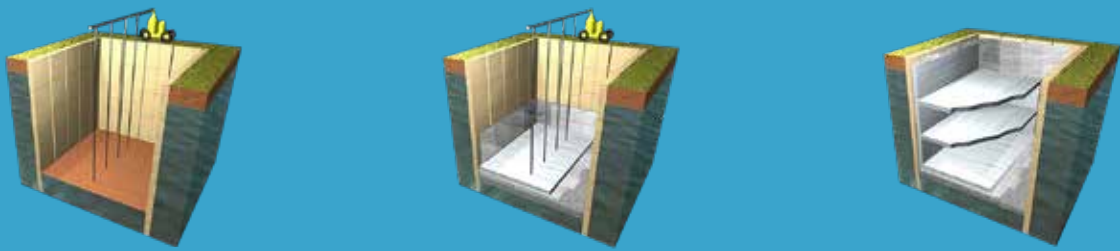

## WATERPROOFING TOP-DOWN WITH DIAPHRAGM WALL

---

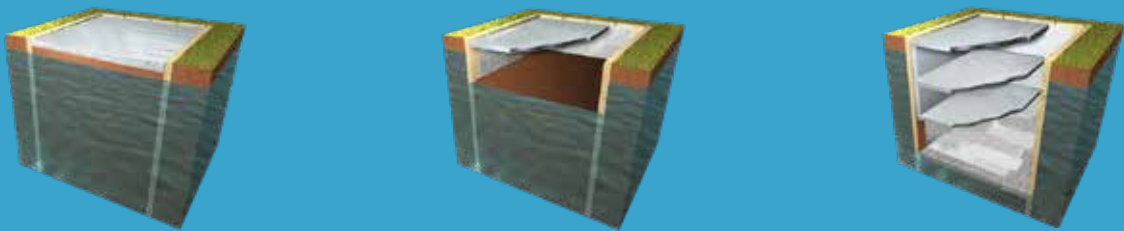

## WATERPROOFING WITH SHEET PILING

---



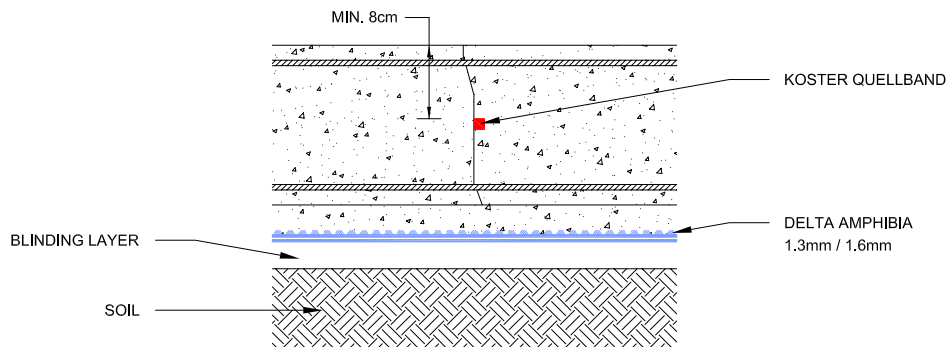
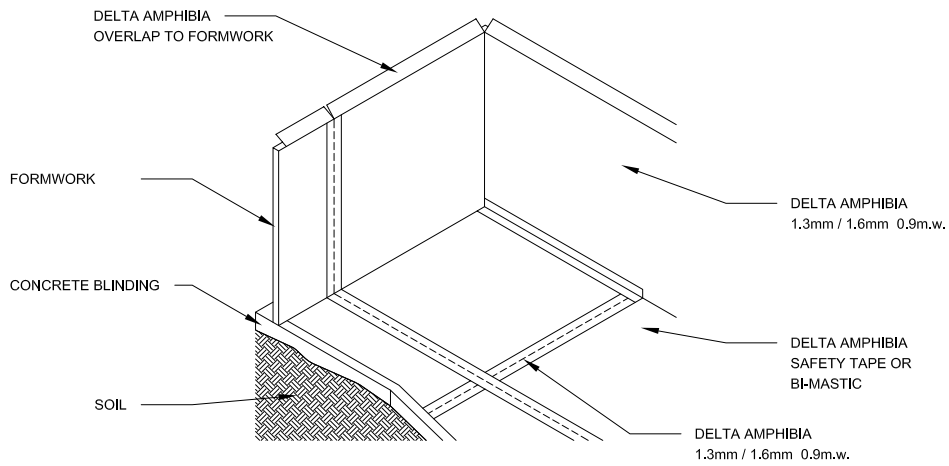
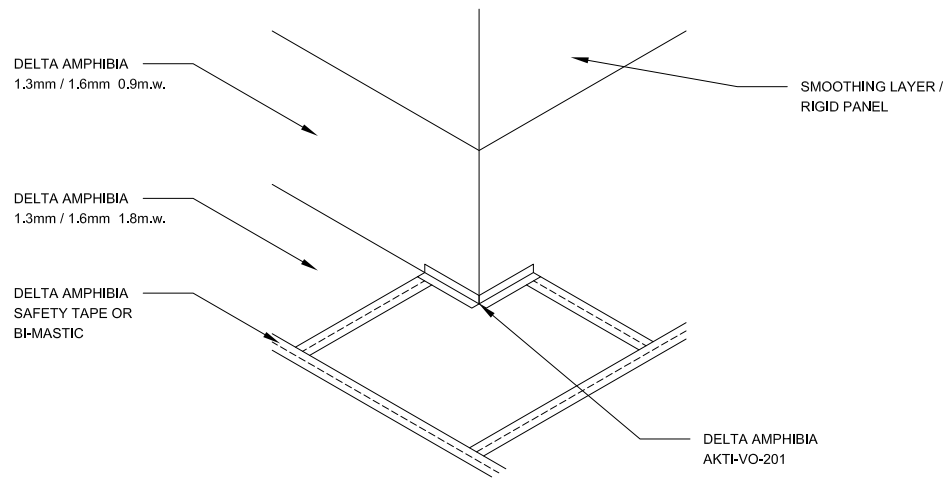
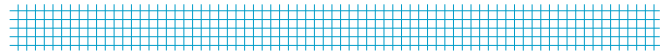

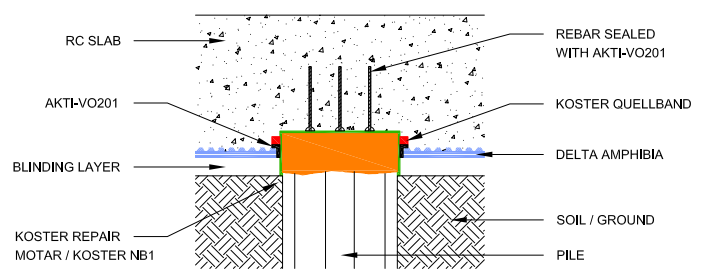
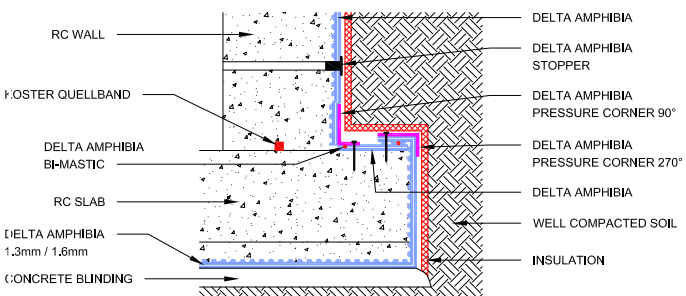
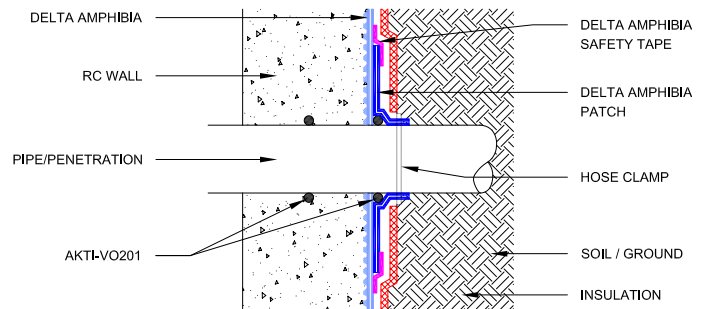
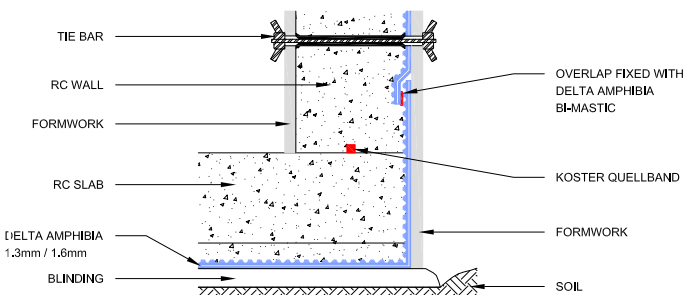
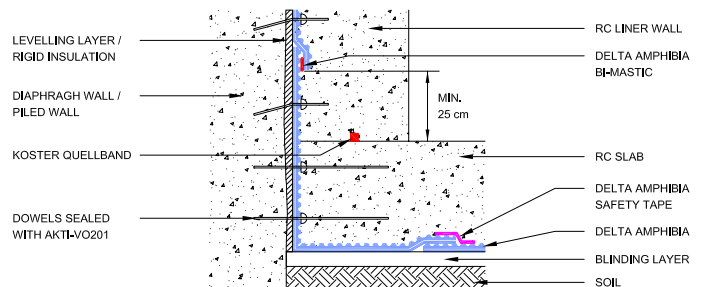
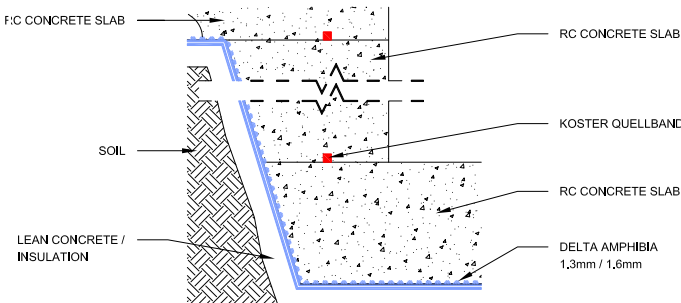
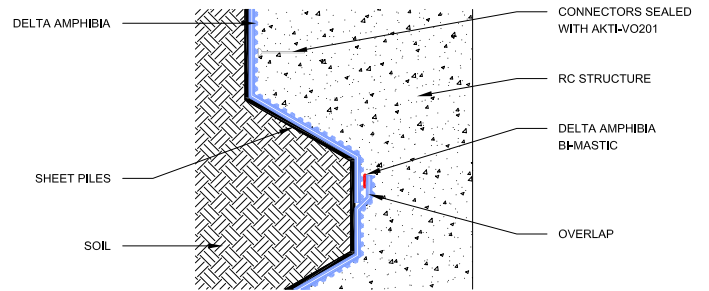
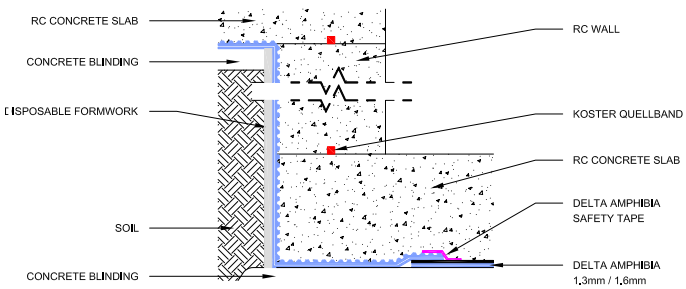

# DEFINITIONS

<b>ACTIVE LEAK</b>	Water penetration through a structure/substrate at a current time.
<b>CAPILLARY BREAK</b>	A hydrophobic material or non-porous material (such as plastic, metal or glass) or gap between parallel layers of material (often less than 1/16" or 1.5 mm) sufficient to stop capillary action.
<b>COLD JOINT</b>	A cold joint is the boundary between concrete steps for example the wall/floor joint.
<b>CONCRETE</b>	A composite material which consists of aggregates, normally natural sand and gravel or crushed rock bound together usually by a hydraulic binder.
<b>CONCRETE SOFFIT</b>	The underside of a building component, usually a flooring section.
<b>CONSTRUCTION JOINT</b>	<p>A construction joint is a concrete joint formed in-situ that is used when a new section of concrete is poured adjacent to another concrete section that has already set or interfacing between masonry or other building materials. Construction joints allow for some horizontal movement, while being rigid against rotational and vertical movement.</p> <p>A construction joint is essentially a planned crack and a Crack is an unplanned joint.</p>
<b>CONTRACTION JOINT</b>	A contraction joint is formed, sawed, or tooled groove in a concrete structure to create a weakened plane to regulate the location of cracking resulting from the dimensional change of different parts of the structure.
<b>CRACK REPAIR</b>	Methods for repairing cracked walls/floors and ensuring that they are watertight.
<b>DUMMY JOINT</b>	A dummy joint is a predetermined breaking point. Usually a groove cut into the top half of a concrete slab, sometimes packed with filler, to form a line where the slab can crack with only minimum damage.
<b>EXPANSION JOINT</b>	An expansion joint is a planned joint which is designed to allow two sections of concrete or masonry to expanding and contract.
<b>FLOOR/WALL JUNCTION</b>	An area where the wall meets the floor/slab in construction.
<b>FIREBREAK</b>	Firebreak products used to provide fire protection by the sealing of linear gaps, service penetrations, movement joints and other necessary openings in fire separating wall and floors.
<b>INSULATING CONCRETE FORM</b>	Insulated concrete form (ICF) is a system of formwork for reinforced concrete usually made with a rigid thermal insulation.

<b>LOAD-BEARING WALL</b>	A load-bearing wall or bearing wall is a wall that is an active structural element of a building, it bears the weight of the elements above wall. Load-bearing walls are one of the earliest forms of construction.
<b>KICKER</b>	A Kicker is small (5-15cm) step/concrete up stand cast above the slab/foundation/floor to position the coordinates for a column or wall formwork for the next construction level.
<b>MOVEMENT JOINT</b>	A movement joint is a planned joint which is designed to permit relative movement caused by expansion due to changes of temperature or moisture.
<b>OVERLAP</b>	Joining sheet edges of adjoining rolls of membrane. Overlapped by the adjoining roll.
<b>PODIUM DECKS</b>	Podium decks are external platforms between and/or attached to building structures.
<b>POST-APPLIED MEMBRANES</b>	Post-Applied membranes are installed after the concrete pour to provide a watertight seal between the membrane and the concrete.
<b>PRESSED JOINT</b>	A pressed joint allows for the transfer of pressure, transverse displacement can be avoided with an interlocking geometry.
<b>PRE-APPLIED MEMBRANES</b>	Pre-Applied waterproofing membranes are a unique system which can easily be applied on blinding concrete for the base slab and to prepared vertical excavation walls (e.g. piled walls, diaphragm walls or similar).
<b>PRE-CAST CONCRETE</b>	Pre-cast concrete is a form of concrete that is prepared, cast and cured off-site, usually in a controlled factory environment.
<b>REVEALS</b>	Reveals are the distance or measurement from the face of a door/window out to the face of the frame on the push side.
<b>SERVICE PENETRATIONS</b>	Service penetrations are created using a cast-in-place sleeve, in a wall or floor assembly, for the purpose of accommodating the passage of a mechanical, electrical or structural service.
<b>SETTLEMENT JOINT</b>	Settlement joints are joint between adjacent parts of a building, structure, or concrete that permits the adjoining masses to settle at slightly different rates.
<b>STEPOC BLOCK STRUCTURES</b>	Stepoc is a system of concrete shuttering blocks that are highly-engineered and dimensionally coordinated.
<b>WATERPROOFING</b>	Make impervious to water, vapour and water ingress.
<b>UNPLANNED MOVEMENT JOINT</b>	An unplanned movement joint can be the cause of shrinkage, creep, thermal movement or to accommodate movement with temperature changes.

**HEAD OFFICE**

Delta House, Merlin Way, North Weald, Epping, Essex, CM16 6HR  
01992 523 523 | [info@deltamembranes.com](mailto:info@deltamembranes.com) | [www.deltamembranes.com](http://www.deltamembranes.com)