

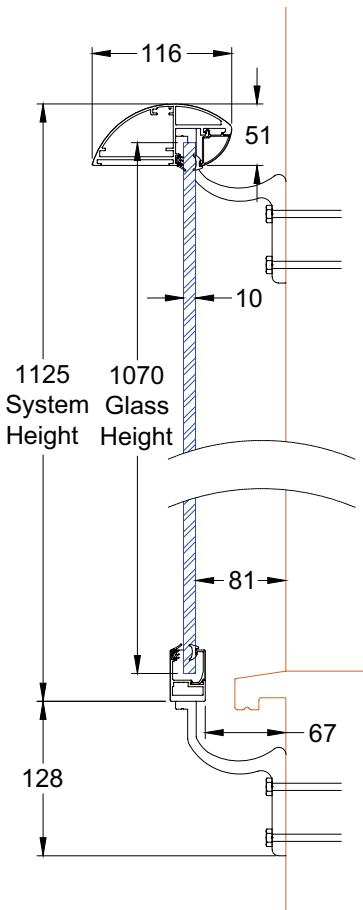

Aerofoil Juliet Installation Instructions



Important

Before commissioning and before starting installation:

1. Read through these instructions and check that you have all the correct parts of your order.
2. Check the height of the glass or glasses.
3. Check the sizes and height against the required height on site making sure they are correct before assembling.*

*Please note the indicated sizes in this document refer to our standard height of such systems.

*Do not scale from the drawings in this document.

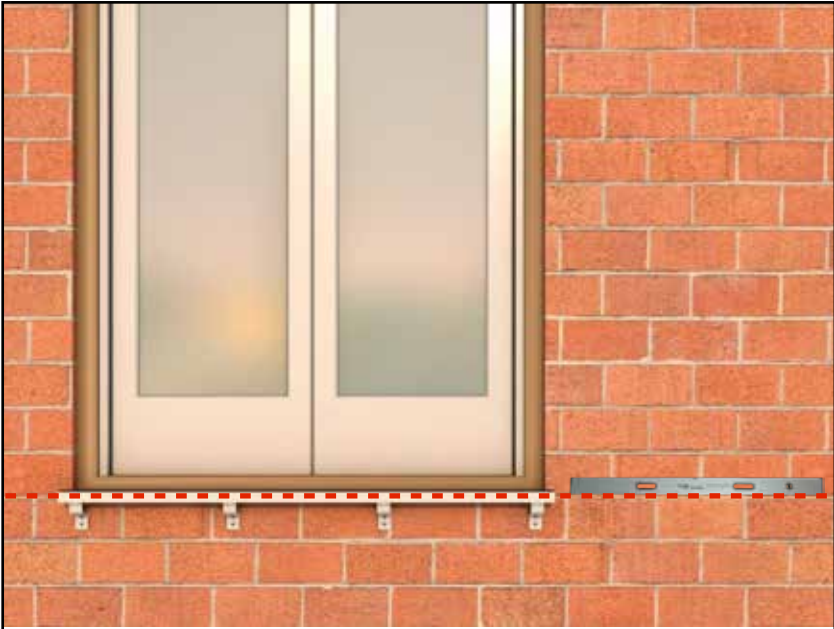

1. Line up bottom track to be level and central with the window opening.



2. Line up bottom track vertically to allow access to the glazing bead from the inside.



3. When properly lined up, fix the bottom track brackets firmly to the wall.
(Use a level to make sure it is horizontally level.)

4. Measure the correct height of the handrail position using the above drawing. Do not scale from this drawing. Check that there is 1100mm minimum from inside to top of handrail.

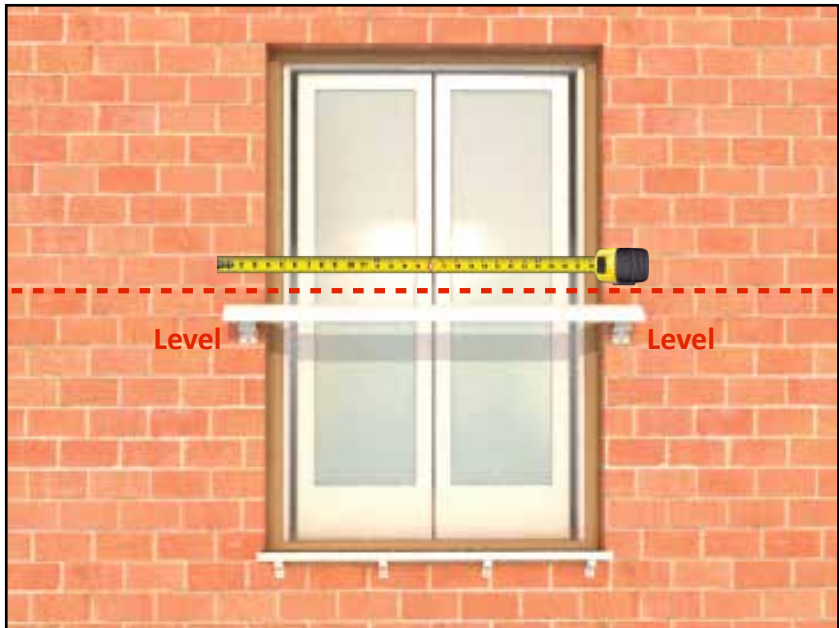

5. Centre the handrail to be central with window giving an equal overlap on both sides.



6. When properly lined up, fix the handrail brackets firmly to the wall.



7. Remove glazing beads if in place.

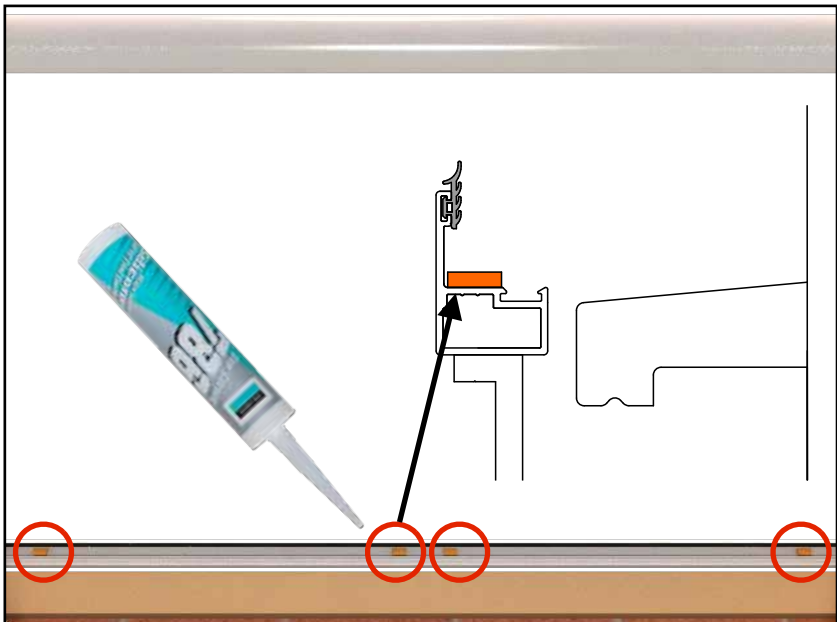

8. Place two spacers on the bottom track for each glass panel and use a dab of silicone to keep them in place.

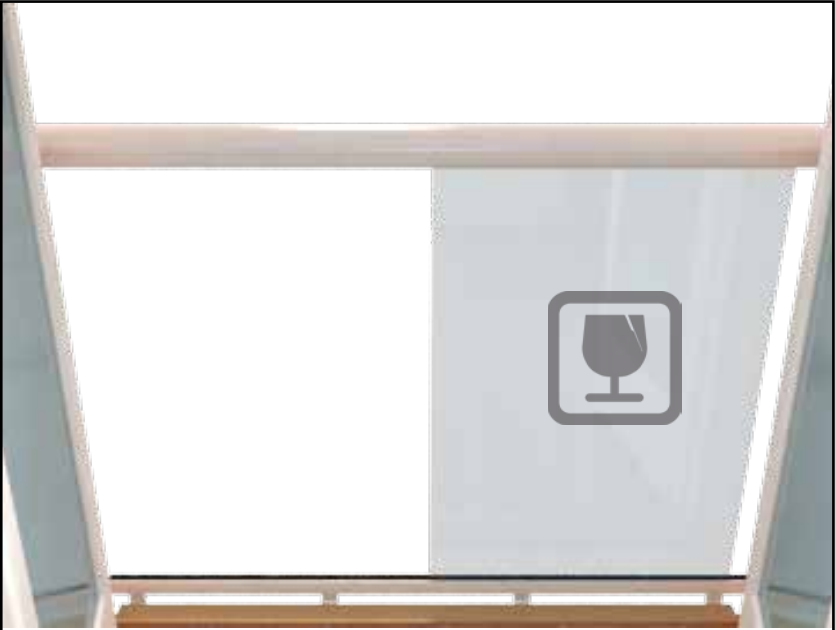

9. Remove any stickers, writing or spacers that are stuck on the glass.

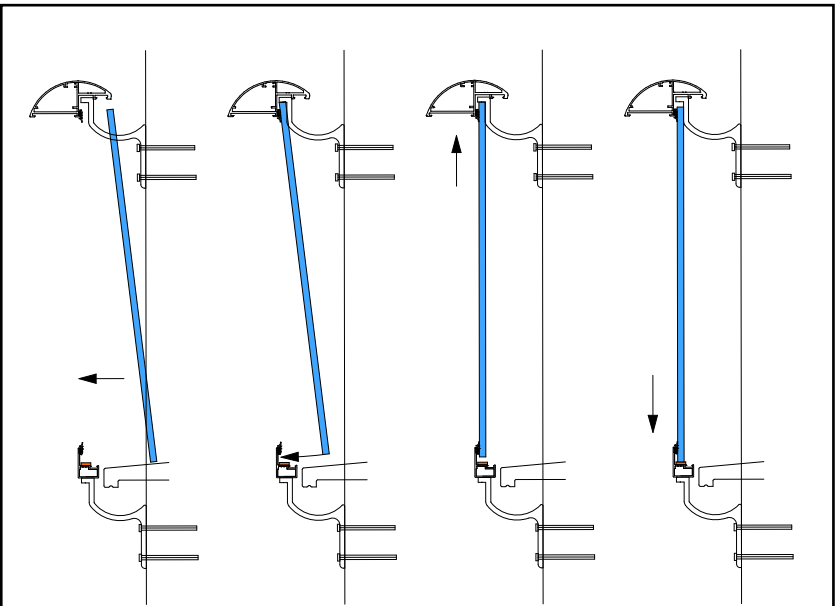

10. Follow these steps to insert the glass panels in position using the temporary glazing beads and rubber gaskets.

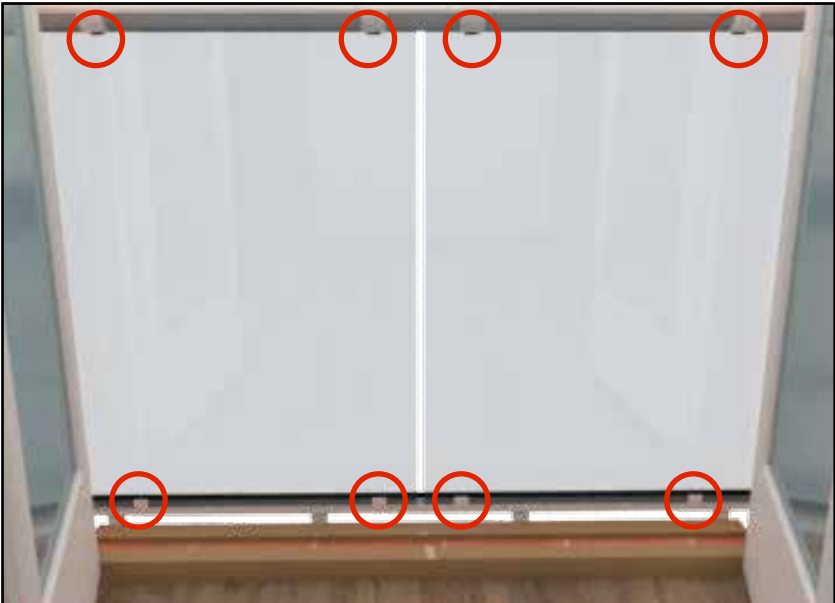

11. Place the glass panels in their positions. To hold them temporarily in position use the small glazing bead pieces provided and 3mm rubber in the handrail and the bottom track.



12. Align all the glass heights and spaces to your satisfaction.

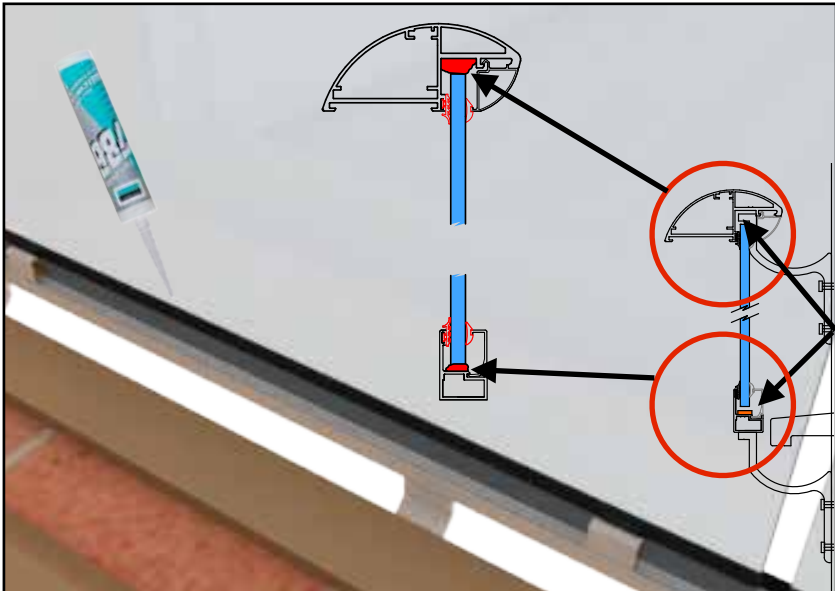

13. Using silicone, fill the space between the bottom of the glass and track and between the top of the glass to the underside of the handrail. Do this along the entire length, top and bottom.



14. When the silicone is dry, replace the small glazing beads with the full length glazing beads top and bottom.

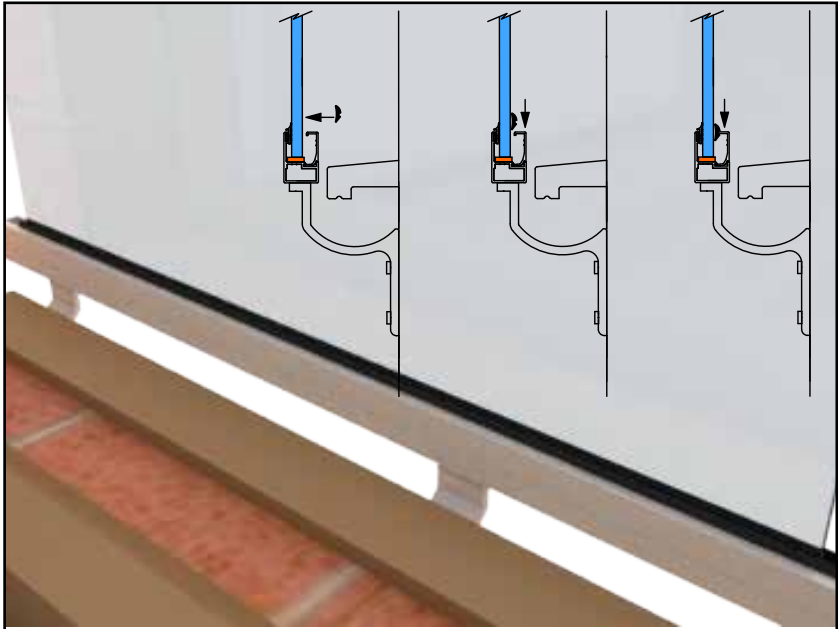

15. When the full length beads are in place push in the 3mm rubber gasket between the glazing bead and glass, soap and water can help.

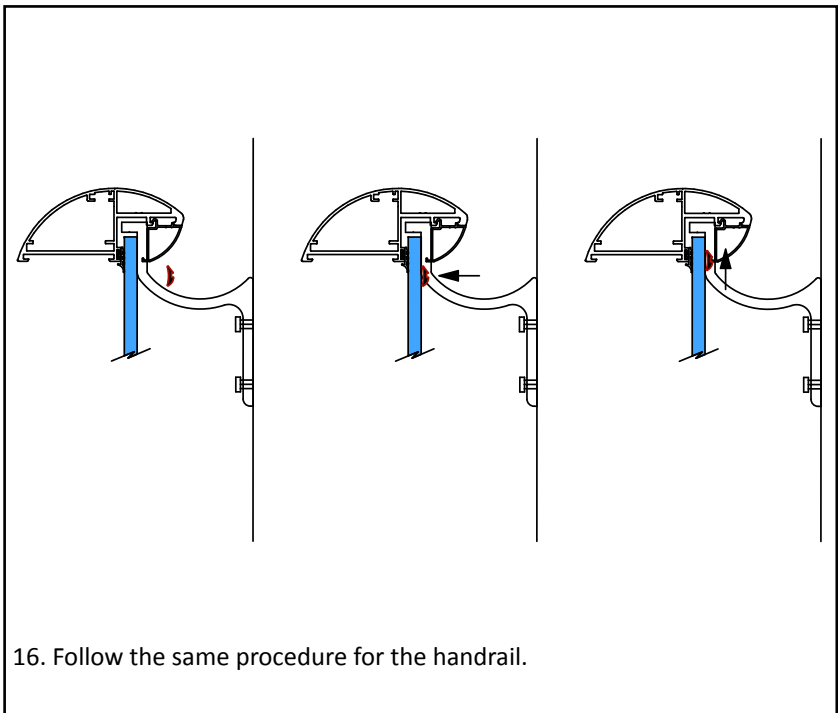

16. Follow the same procedure for the handrail.



17. Trim off any excess rubber.







Hybrid[®]

© Balconette 2017

www.balconette.co.uk

01342 410411

Balconette is a trading name of Balcony Systems Solutions Limited.

Registered in England under company registration no. 06937600.

Registered office: Unit 6 Systems House, Eastbourne Road, Blindley Heath, RH7 6JP