



YOU'LL NEVER BE BETTER PROTECTED

Slope Fittings



- EXTENDED RANGE NOW AVAILABLE FOR STEEPER GRADIENTS
- FITTINGS TOLERANCE ALLOWS FOR ON SITE ANGLE VARIATIONS
- ENHANCED AESTHETICS FOR THE FINISHED HANDRAIL
- QUICK AND EASY INSTALLATION





55A Variable Elbow (11° to 30°)

The Type 55A is an ideal fitting to use as an alternative to bending or when a junction between a sloping tube and an end post is required.

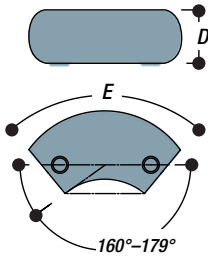

TYPE	Tube ref.	mm		Kg
	A	D	E	
55A-7	7	55	115	0.82
55A-8	8	60	150	1.01

427 Three Socket Tee (30° to 45°)

This fitting is used on a safety railing with slopes between 30° and 45° and fixes the top rail to a vertical intermediate upright.

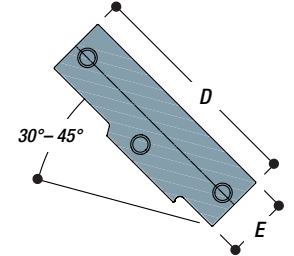
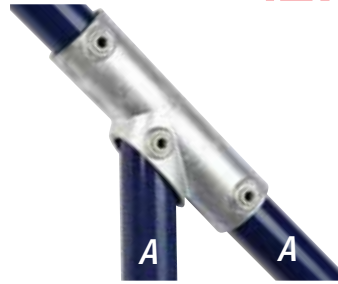

TYPE	Tube ref.	mm		Kg
	A	D	E	
427-7	7	180	55	0.95
427-8	8	216	60	1.22

56A Acute Angle Elbow (11° to 30°)

Type 56A is an ideal fitting to use as an alternative to bending, or when a junction between a sloping tube and an end post is required i.e. guardrail on staircases between 11° and 30°

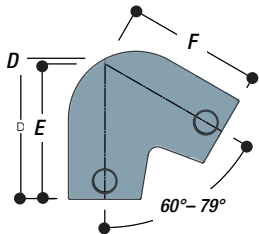

TYPE	Tube ref.	mm			Kg
	A	D	E	F	
56A-7	7	120	108	108	0.94
56A-8	8	125	112	112	1.12

56-7 Acute Angle Elbow (30° to 45°)

Type 56 is an ideal fitting to use as an alternative to bending, or when a junction between a sloping tube and an end post is required i.e. guardrail on staircases between 30° and 45°

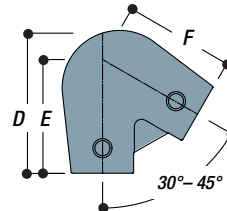
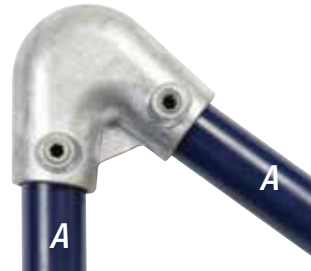

TYPE	Tube ref.	mm			Kg
	A	D	E	F	
56-7	7	105	99	99	0.98

329 Single Socket Tee (11° to 30°)

Designed as an alternative to Type 12, this adjustable fitting is most frequently used for bracing and struts and for terminating the mid-rail on sloping guardrails into the end upright. It may be used at any selected angle between 11° and 30°

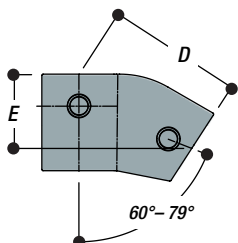
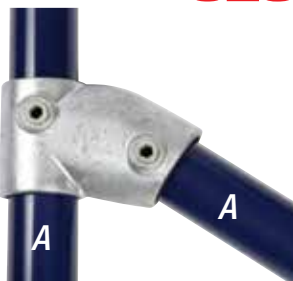

TYPE	Tube ref.	mm		Kg
	A	D	E	
329-7	7	99	54	0.73
329-8	8	109	59	0.86

325 Level to Sloping Down Tee (30° to 45°)

This fitting is designed for the top rail on guardrail on slopes and staircases between 30° and 45° at the junction where the handrail changes from level to sloping down the stairs

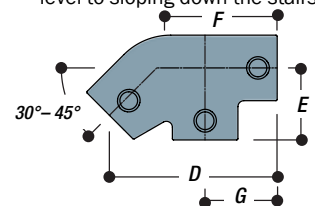

TYPE	Tube ref.	mm				Kg
	A	D	E	F	G	
325-7	7	142	60	89	60	1.02
325-8	8	154	68	100	68	1.12

326 Level to Sloping Down or Up Cross (30° to 45°)

Cross fitting designed for the mid rail on guardrail on slopes and staircases between 30° and 45° at the junction where the handrail changes from either level to sloping down or level to sloping up the stairs

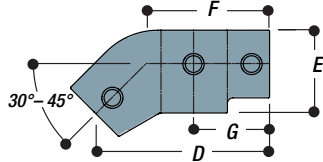
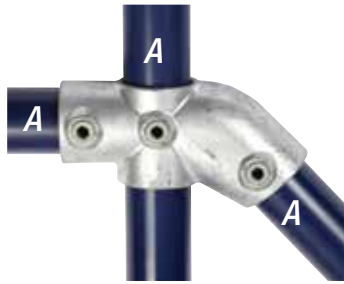

TYPE	Tube ref.	mm				Kg
	A	D	E	F	G	
326-7	7	142	68	89	60	0.82
326-8	8	154	74	100	68	0.95

320RH Right hand level to Sloping Down Side Outlet Elbow (30° to 45°)

Right Hand Side Outlet Elbow fitting designed for the top rail on guardrail on slopes and staircases between 30° and 45° at the junction where the handrail changes from level to sloping down the stairs

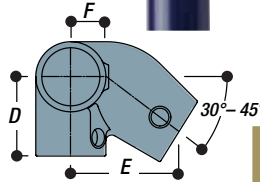
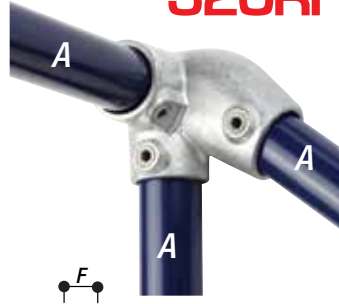

TYPE	Tube ref.	mm			Kg
	A	D	E	F	
320RH-7	7	60	86	29	1.08
320RH-8	8	68	93	32	1.28

325A Level to Sloping Up Tee (30° to 45°)

Tee fitting designed for the top rail on guardrail on slopes and staircases between 30° and 45° at the junction where the handrail changes from level to sloping up the stairs

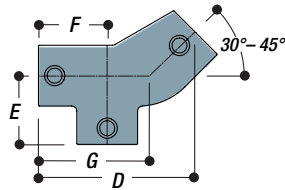
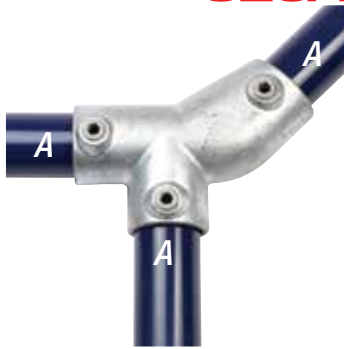

TYPE	Tube ref.	mm				Kg
	A	D	E	F	G	
325A-7	7	142	60	60	89	1.02
325A-8	8	155	68	68	100	1.12

321LH Left hand level to Sloping Down Side Outlet Tee (30° to 45°)

Left Hand Side Outlet Tee fitting designed for the mid rail on guardrail on slopes and staircases between 30° and 45° at the junction where the handrail changes from level to sloping down the stairs

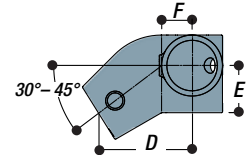
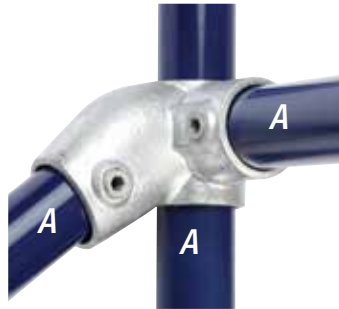

TYPE	Tube ref.	mm			Kg
	A	D	E	F	
321LH-7	7	86	27	29	0.96
321LH-8	8	92	30	32	1.12

320LH Left hand level to Sloping Down Side Outlet Elbow (30° to 45°)

Left Hand Side Outlet Elbow fitting designed for the top rail on guardrail on slopes and staircases between 30° and 45° at the junction where the handrail changes from level to sloping down the stairs

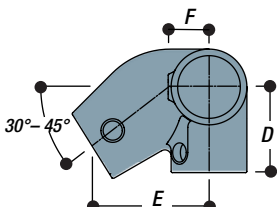
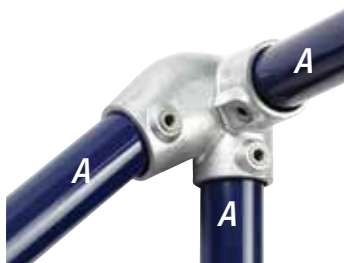

TYPE	Tube ref.	mm			Kg
	A	D	E	F	
320LH-7	7	60	86	29	1.08
320LH-8	8	68	93	32	1.28

321RH Right hand level to Sloping Down Side Outlet Tee (30° to 45°)

Right Hand Side Outlet Tee fitting designed for the mid rail on guardrail on slopes and staircases between 30° and 45° at the junction where the handrail changes from level to sloping down the stairs

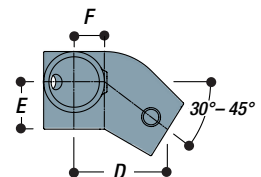
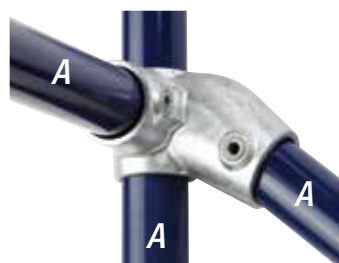

TYPE	Tube ref.	mm			Kg
	A	D	E	F	
321RH-7	7	86	27	29	0.96
321RH-8	8	92	30	32	1.12

Guardrail Up Slopes 11 to 30

Using Types 55A, 56A, 327, 328, & 329 size 7 & 8

Where the upright remains vertical, i.e. stairways (i) dimension x, x1, x2, x3 to be subtracted from the upright centres; dimension (L) to give the rail length; (ii) dimension y, y1 and y2 for determining the up-right length.

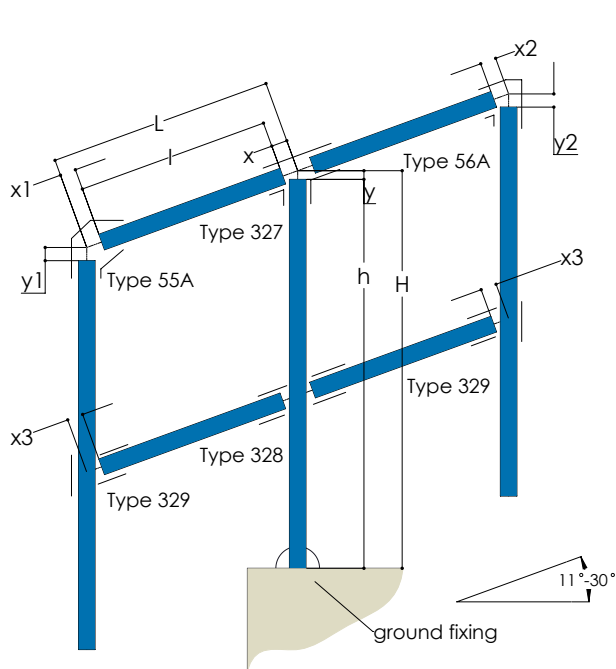

Table 1 gives details of dimensions required for calculating the rail lengths, where angle are between 11° & 30°

Table 1: Rails

Angle Of Slope	Fitting Size							
	7				8			
	x	x1	x2	x3	x	x1	x2	x3
11°	-26	-25	-35	-52	-29	-16	-35	-51
15°	-28	-21	-46	-53	-31	-27	-47	-52
20°	-30	-16	-48	-55	-34	-21	-49	-54
25°	-33	-15	-52	-59	-38	-22	-53	-57
30°	-37	-8	-57	-64	-42	-15	-59	-62

Table 2 Gives details of dimensions required for calculating the upright lengths.

Table 2: Uprights

Angle Of Slope	Fitting Size					
	7			8		
	y	y1	y2	y	y1	y2
11°	+7	-10	-28	+6	-7	-33
15°	+7	-11	-25	+6	-8	-30
20°	+7	-13	-34	+6	-10	-38
25°	+7	-15	-43	+6	-10	-48
30°	+7	-18	-53	+6	-14	-59

Guardrail up Slopes 30 to 45

Using Types 29, 30, 55, 56 & 427 in sizes 7 & 8

Where the upright remains vertical, i.e. stairways (i) dimension x, x1, x3, y & z to be subtracted from the upright centres; dimension (L) to give the rail length; (ii) dimension u, v and w for determining the upright length.

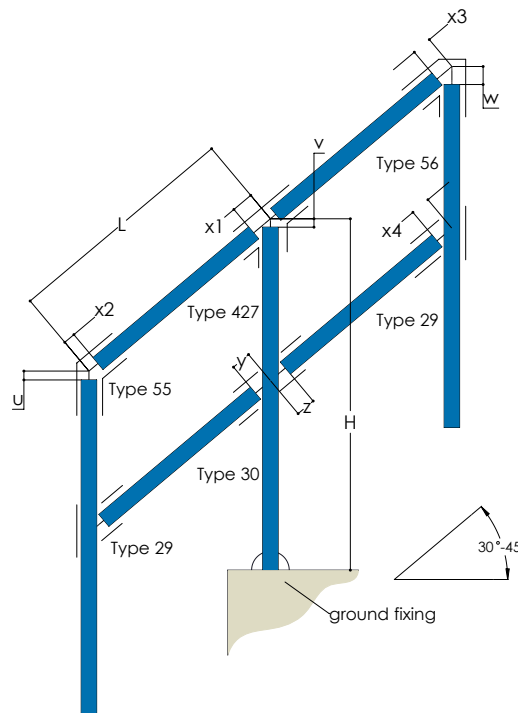

Table 3 gives details of dimensions required for calculating the rail lengths, where angle are between 30° & 45°

Table 3: Rails

Angle Of Slope	Fitting Size											
	7						8					
	x1	x2	x3	x4	y	z	x1	x2	x3	x4	y	z
30°	-39	-20	-55	-37	-49	-55	-45	-22	-49	-43	-60	-74
35°	-44	-16	-61	-40	-50	-54	-50	-18	-55	-47	-60	-74
40°	-47	-20	-71	-45	-51	-53	-55	-21	-66	-52	-61	-74
45°	-50	-26	-85	-51	-91	-53	-55	-26	-81	-59	-68	-66

Table 4 Gives details of dimensions required for calculating the upright lengths..

Table 4: Uprights

Angle Of Slope	Fitting Size					
	7			8		
	u	v	w	u	v	w
30°	-17	+5	-48	-25	+6	-49
35°	-16	+5	-59	-21	+6	-59
40°	-8	+3	-69	-14	+6	-69
45°	+2	-1	-80	-2	-4	-81

Guardrail up slopes 30° to 45°

Using 325, 325A, 326, size 7 & 8

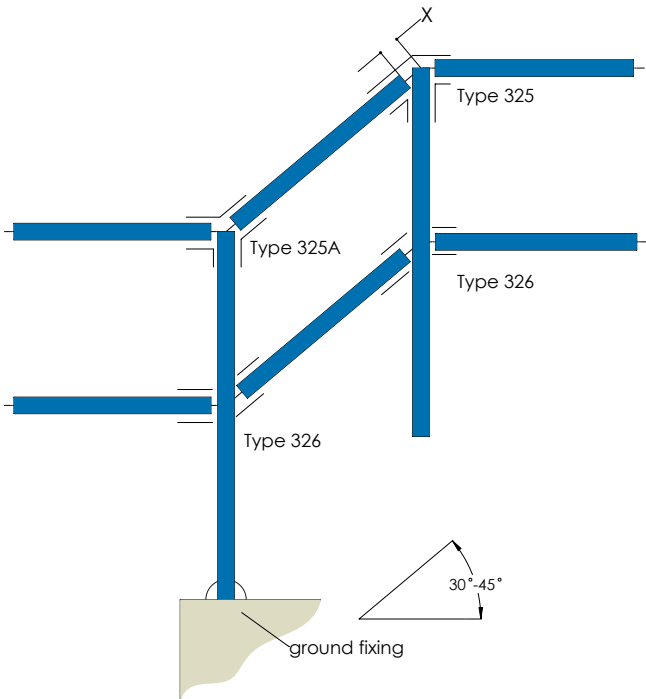

Guardrail up slopes 30° to 45°

Using 320RH, 320LH, 321RH & 321LH size 7 and 8

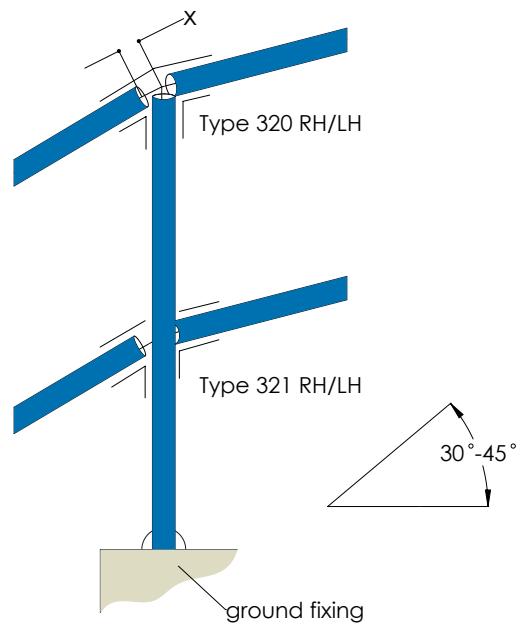

Table 5 gives details of dimensions required for calculating the rail lengths, where angle are between 30° & 45°

Table 5: Rails

Angle Of Slope	Fitting Size	
	7	8
	x	x
30°	-47	-57
35°	-52	-62
40°	-59	-69
45°	-68	-79

Table 6 gives details of dimensions required for calculating the rail lengths, where angle are between 30° & 45°

Table 6: Rails

Angle Of Slope	Fitting Size	
	7	8
	x	x
30°	-55	-62
35°	-60	-68
40°	-67	-76
45°	-77	-86

New Slope Fittings

The latest addition to the **KEE KLAMP** portfolio is an extension to the current range of slope fittings designed to enhance the building of guardrail along staircases and ramps particularly when the slope is greater than 30°. The new range introduces single fittings to cater for situations where currently a combination of fittings is required. Not only does this improve the aesthetics of the finished guardrail but it also allows for a quicker and easier install. The new range of slope fittings is available in Size 7 (outer diameter 42.4mm) and Size 8 (outer diameter 48.3mm) designed for use with steel tubing to BS EN 10255.

KEE KLAMP fittings are iron castings manufactured to the requirements of BS EN 1562 & BS EN 1563. They are supplied hot dip galvanised to BS EN ISO 1461.

A **KEE KLAMP** fitting can support an axial load of 900Kg per set screw tightened to a torque of 4Kgm (39 Nm). In common with all **KEE KLAMP** products, the threaded recesses of each fitting are covered with **THREDKOAT** protective coating to provide enhanced corrosion resistance and all grub screws are manufactured in case hardened steel coated with **KEE KOAT** for corrosion protection.

Features & Benefits

- KEE KLAMP is the best known brand of slip-on tube fittings available for over 80 years
- Manufactured to stringent quality standards to ensure consistent performance
- Extended range of slope fittings gives greater design flexibility
- Adjustability in the fittings allows greater on-site tolerances to be met
- Using single fittings rather than pairs speed up installation times





Kee Safety Limited
 Cradley Business Park
 Overend Road
 Cradley Heath
 B64 7DW, UK

Tel: +44 (0) 1384 632 188
 Fax: +44 (0) 1384 632 192

Email: sales@keesafety.com
 Website: www.keesafety.co.uk