

Aluminium floor access covers for hard finishes

Features

- Covers can be fitted quickly and unobtrusively into all types of hard floor finish: ceramic tiles, marble, terrazzo, resin or parquet.
- Unique patented cover sections are tapered for easy removal, and frame sections give a good key to bedding mortar. Covers are precision-made to avoid distortion.
- Top edge seal on aluminium covers helps prevent dirt, grout or grinding waste penetrating joint between cover and frame. Double seals are available.
- Lifting blocks are anchored to the inner frame. Stainless steel securing bolts are stiletto heel proof.
- Optional brass, stainless steel or coloured high impact pvc show edge on aluminium 5000 series is continuously secured; there are no fasteners to rust or break.
- Quality control to BS EN ISO 9001.

General notes on 5000 series floor access covers

Size – All covers are made to measure using the Howe Green patented system. This allows the manufacture of any size between the stated maximum and minimum dimensions. Sizes that may be thought 'non-standard' can therefore be obtained without delay and without cost surcharge. The versatile nature of the Howe Green system allows any configuration of ducts and branches to be created.

Weight – The weight of the access cover should be taken into account where ease of handling is an important consideration. In all cases reference should be made to the Manual Handling Operations Regulations 1992, which implement European Directive 90/269/EEC. If loads are excessive, consideration should be given to the use of hydraulic lifters, or our HSE 75 range.

Where large covers are necessary, over pits containing plant etc., the main covers can be fitted with small inset covers to allow easy access for routine maintenance. The main covers need then only be removed for major overhauls or plant replacement.



5000 Series Aluminium Single Cover

floor access covers for pedestrian traffic

Typical floor finishes

Ceramic tiles, marble, terrazzo, concrete, resin, wood and all hard floors.

Performance

Pedestrian traffic (including wheeled trolleys, sack trucks etc.) only.

Options

Every cover is available with a choice of aluminium or brass show edge, and matching lifting blocks, or Colouredge high impact pvc edges with aluminium lifting blocks (see website). Double seal. 1 hour fire rating to BS 476: Part 20: 1987 available; ask for indicative test report.

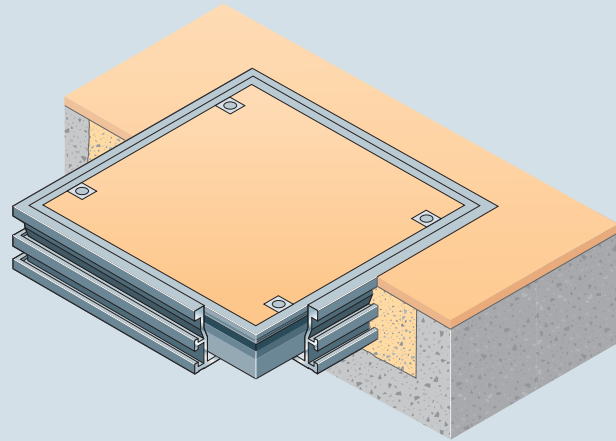

Cross section showing concrete and timber sub-floors (scale 1:2)

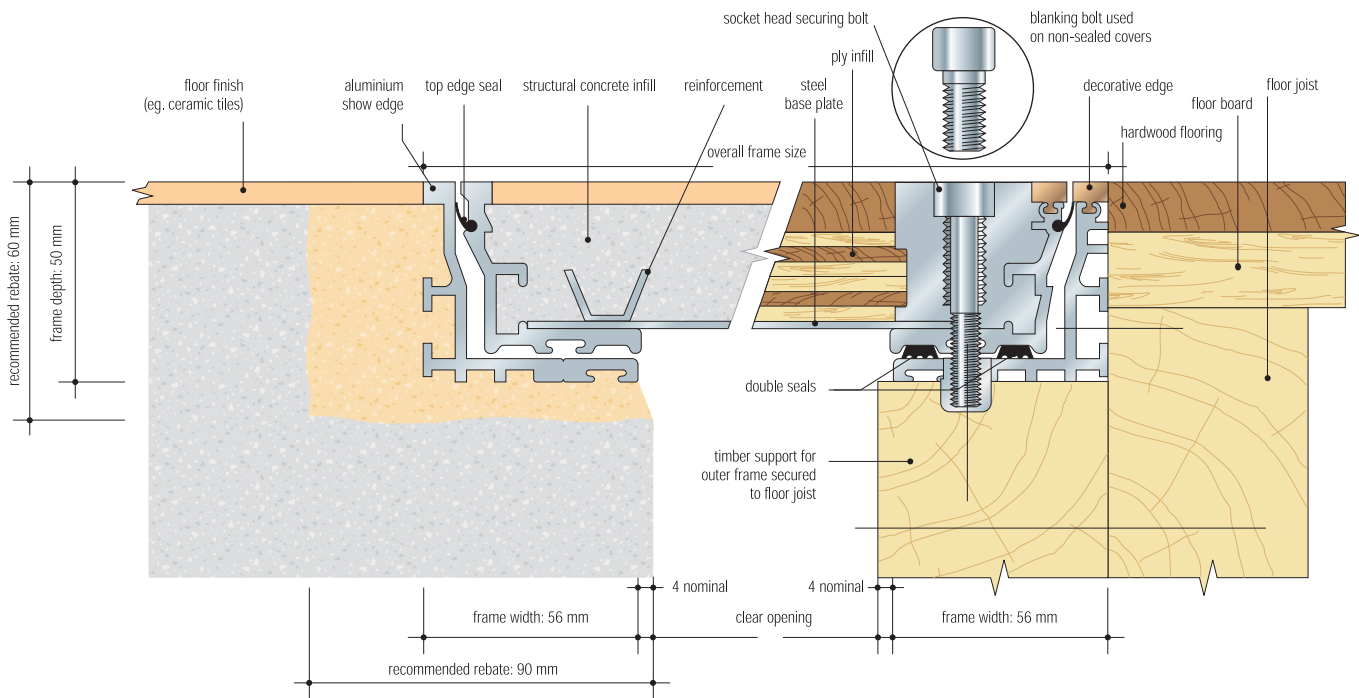

Typical specification clause for 5000 series

Recessed floor access/ duct/ multipart* covers and frames shall be Howe Green Ltd 5000 series with 1 hour fire rating to BS 476: Part 20: 1987, continuously fastened aluminium/ brass/ Colouredge*, top edge dirt seal and mechanically jointed corners, stainless steel/steel* baseplate and reinforcement, double sealed with socket head securing bolts/unsealed with blanking bolts*. Sizes shall be as shown on contract drawings nos† Covers to be supplied complete with† sets of combined lifting / securing keys. All to be manufactured and supplied by Howe Green Ltd, Marsh Lane, Ware, Hertfordshire, SG12 9QQ, Great Britain, and installed in accordance with the manufacturer's installation details and sitework guide.

* Delete as appropriate. † Insert appropriate numbers & quantities

Size

Overall frame size = clear opening + 120 mm e.g. 600 x 600 mm clear opening = 720 x 720 mm overall frame. Subject to correct infill/installation (see separate guide). See also general notes on cover.

Weight

A 5000 series cover when filled with concrete weighs approx. 90kg/m². See also general notes on cover.

Maximum / minimum sizes

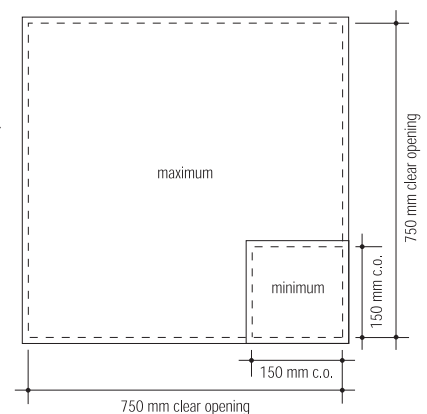

5000 Series Aluminium Duct Cover

floor access covers for pedestrian traffic

Typical floor finishes

Ceramic tiles, marble, terrazzo, concrete, resin, wood and all hard floors.

Performance

Pedestrian traffic (including wheeled trolleys, sack trucks etc.) only.

Options

Every cover is available with a choice of aluminium or brass show edge, and matching lifting blocks, or Colouredge high impact pvc edges with aluminium lifting blocks (see website). Double seal.

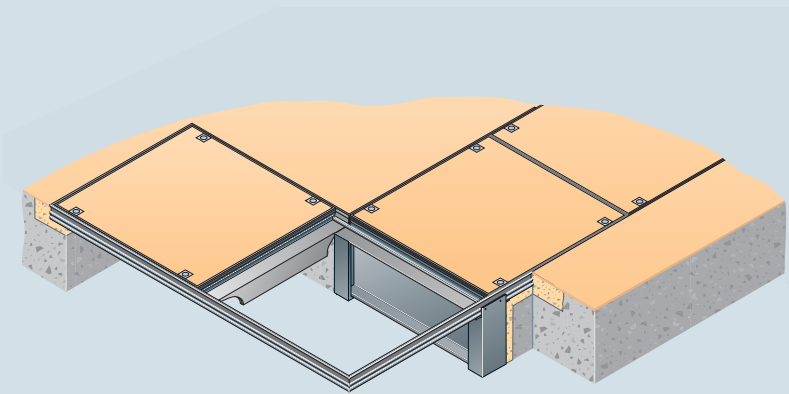

Cross section showing anchor lugs and locking/lifting detail (scale 1:2)

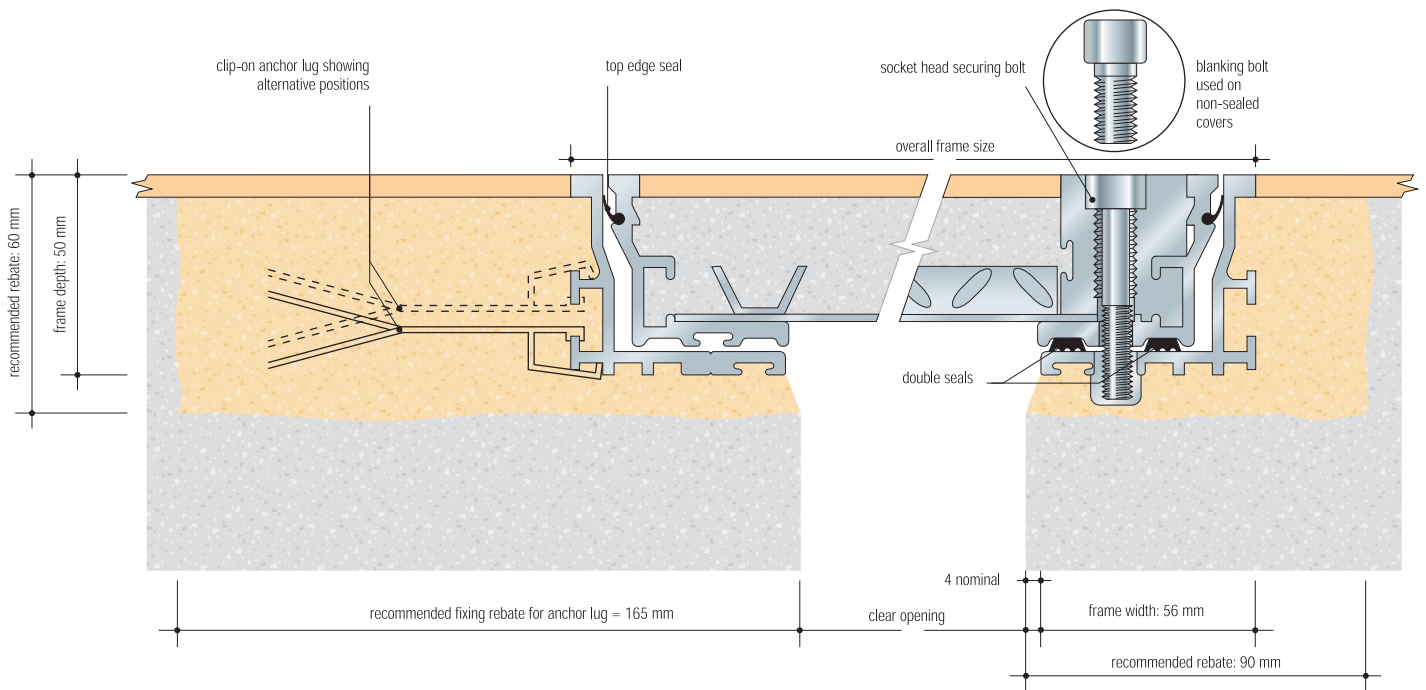

Size

Overall frame size = clear opening + 120 mm e.g. 600 x 900 mm
 clear opening = 720 x 1020 mm
 overall frame. Subject to correct infill/installation (see separate guide).
 See also general notes on cover.

Weight

A 5000 series cover when filled with concrete weighs approx. 90 kg/m². See also general notes on cover.

Typical Layout

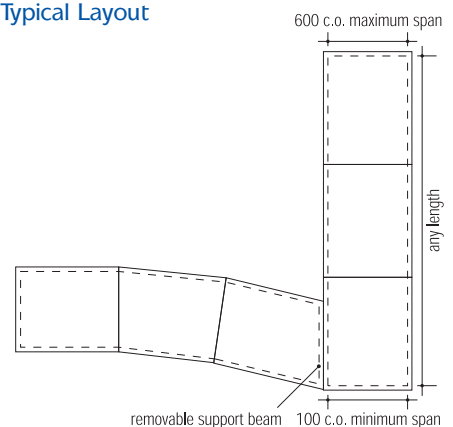



5000 Series Aluminium Multipart Cover

floor access covers for pedestrian traffic

Typical floor finishes

Ceramic tiles, marble, terrazzo, concrete, resin, wood and all hard floors.

Performance

Pedestrian traffic (including wheeled trolleys, sack trucks etc.) only.

Options

Every cover is available with a choice of aluminium or brass show edge, and matching lifting blocks, or Colouredge high impact pvc edges with aluminium lifting blocks (see website). Double seal.

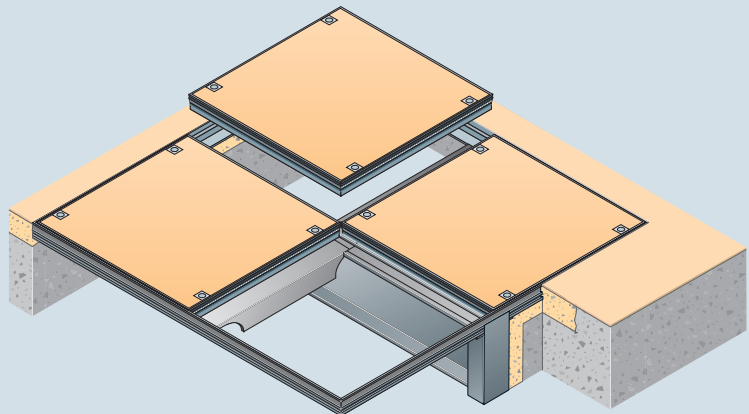

Cross section showing removable support beam and cross members (scale 1:5)

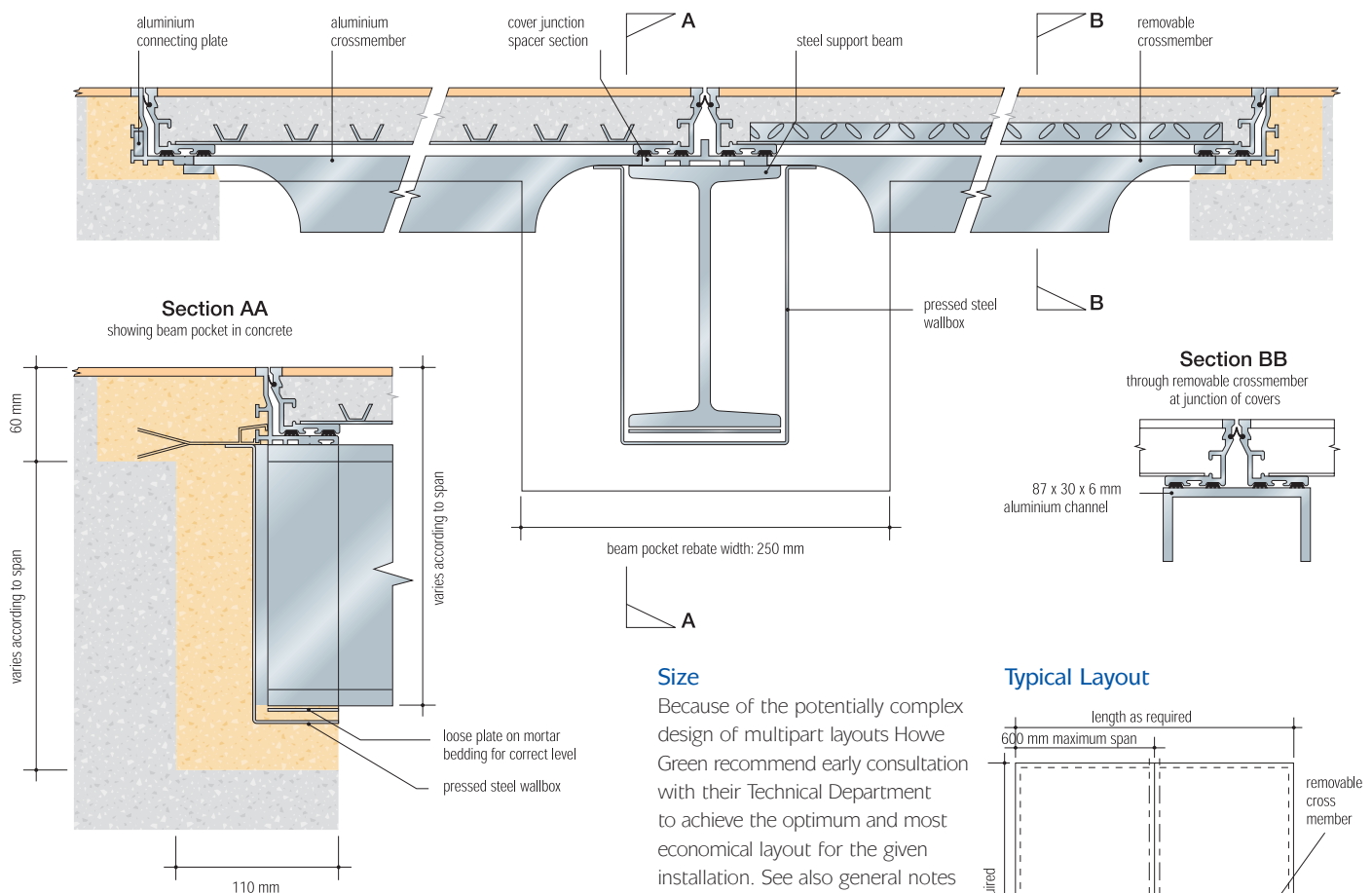

Size

Because of the potentially complex design of multipart layouts Howe Green recommend early consultation with their Technical Department to achieve the optimum and most economical layout for the given installation. See also general notes on cover.

Weight

A 5000 series cover when filled with concrete weighs approx. 90 kg/m². See also general notes on cover.

Typical Layout

